

# RETAIL PRICE LIST

EFFECTIVE MAY 2021

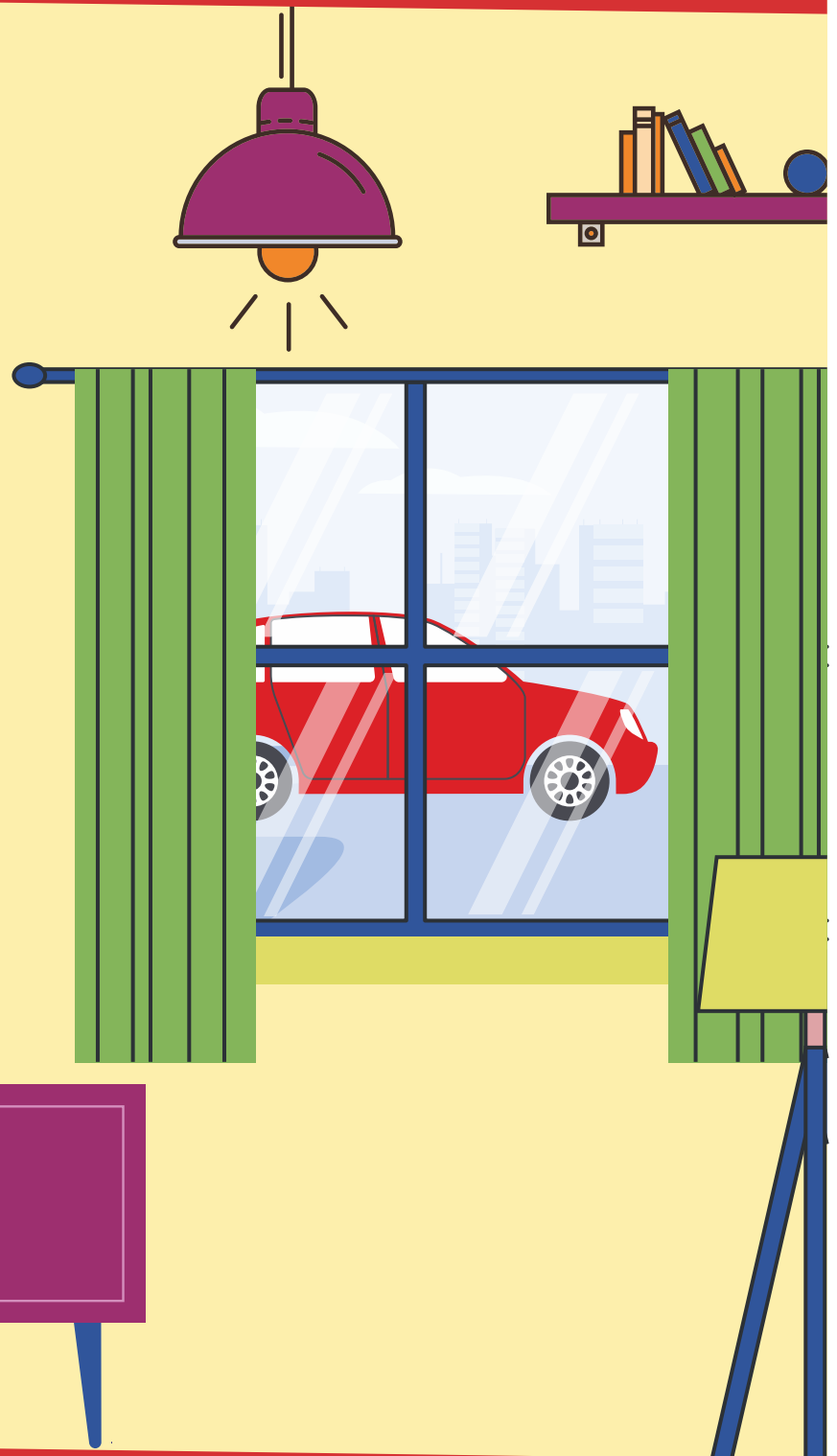

**MINIATURE  
CIRCUIT BREAKER**



**DISTRIBUTION  
BOARD**



**MOULDED CASE  
CIRCUIT BREAKER**



**AUTOMATIC  
CHANGEOVER WITH  
CURRENT LIMITER**



**WIRING DEVICES**



**Caretron™ MINIATURE CIRCUIT BREAKER - MCB**

- ISI / CE Marked as per IS/IEC 60898 -1 • Degree of Protection IP 20 • 25 sq. mm Terminals • Breaking Capacity 6kA
- Bi-Connect Terminals • Positive Isolation • Frequency 50Hz • Operating Voltage 240V / 415V AC, 60V DC per Pole

**B CURVE SINGLE POLE**

HSN Code: 8536

	Rating (A)	Pack	Cat. Nos.	Unit Price (₹)
	6	1/12/180	810000	190
10	1/12/180	810001	190	
16	1/12/180	810002	190	
20	1/12/180	810003	190	
25	1/12/180	810004	190	
32	1/12/180	810005	190	
40	1/12/180	810006	422	
50	1/12/180	810007	476	
63	1/12/180	810008	476	

**B CURVE SINGLE POLE NEUTRAL**

HSN Code: 8536

	Rating (A)	Pack	Cat. Nos.	Unit Price (₹)
	6	1/6/90	810009	640
10	1/6/90	810010	640	
16	1/6/90	810011	640	
20	1/6/90	810012	640	
25	1/6/90	810013	640	
32	1/6/90	810014	640	
40	1/6/90	810015	924	
50	1/6/90	810016	1022	
63	1/6/90	810017	1022	

**B CURVE DOUBLE POLE**

HSN Code: 8536

	Rating (A)	Pack	Cat. Nos.	Unit Price (₹)
	6	1/6/90	810018	658
10	1/6/90	810019	658	
16	1/6/90	810020	658	
20	1/6/90	810021	658	
25	1/6/90	810022	658	
32	1/6/90	810023	658	
40	1/6/90	810024	952	
50	1/6/90	810025	1068	
63	1/6/90	810026	1068	

**C CURVE SINGLE POLE**

HSN Code: 8536

	Rating (A)	Pack	Cat. Nos.	Unit Price (₹)
	6	1/12/180	810054	192
10	1/12/180	810055	192	
16	1/12/180	810056	192	
20	1/12/180	810057	192	
25	1/12/180	810058	192	
32	1/12/180	810059	192	
40	1/12/180	810060	428	
50	1/12/180	810061	502	
63	1/12/180	810062	502	

**Caretron™ MINIATURE CIRCUIT BREAKER - MCB**

- ISI / CE Marked as per IS/IEC 60898 -1 • Degree of Protection IP 20 • 25 sq. mm Terminals • Breaking Capacity 6kA
- Bi-Connect Terminals • Positive Isolation • Frequency 50Hz • Operating Voltage 240V / 415V AC, 60V DC per Pole

**C CURVE SINGLE POLE NEUTRAL**

HSN Code: 8536

	Rating (A)	Pack	Cat. Nos.	Unit Price (₹)
	6	1/6/90	810063	654
10	1/6/90	810064	654	
16	1/6/90	810065	654	
20	1/6/90	810066	654	
25	1/6/90	810067	654	
32	1/6/90	810068	654	
40	1/6/90	810069	908	
50	1/6/90	810070	1076	
63	1/6/90	810071	1076	

**C CURVE DOUBLE POLE**

HSN Code: 8536

	Rating (A)	Pack	Cat. Nos.	Unit Price (₹)
	6	1/6/90	810072	662
10	1/6/90	810073	662	
16	1/6/90	810074	662	
20	1/6/90	810075	662	
25	1/6/90	810076	662	
32	1/6/90	810077	662	
40	1/6/90	810078	968	
50	1/6/90	810079	1088	
63	1/6/90	810080	1088	

**C CURVE THREE POLE**

HSN Code: 8536

	Rating (A)	Pack	Cat. Nos.	Unit Price (₹)
	6	1/4/60	810081	1086
10	1/4/60	810082	1086	
16	1/4/60	810083	1086	
20	1/4/60	810084	1086	
25	1/4/60	810085	1086	
32	1/4/60	810086	1086	
40	1/4/60	810087	1534	
50	1/4/60	810088	1688	
63	1/4/60	810089	1688	

**C CURVE THREE POLE NEUTRAL**

HSN Code: 8536

	Rating (A)	Pack	Cat. Nos.	Unit Price (₹)
	6	1/3/45	810090	1436
10	1/3/45	810091	1436	
16	1/3/45	810092	1436	
20	1/3/45	810093	1436	
25	1/3/45	810094	1436	
32	1/3/45	810095	1436	
40	1/3/45	810096	1902	
50	1/3/45	810097	2074	
63	1/3/45	810098	2074	

**Caretron™ MINIATURE CIRCUIT BREAKER - MCB**

**C CURVE FOUR POLE**

**HSN Code: 8536**

	Rating (A)	Pack	Cat. Nos.	Unit Price (₹)
	6	1/3/45	810099	1438
10	1/3/45	810100	1438	
16	1/3/45	810101	1438	
20	1/3/45	810102	1438	
25	1/3/45	810103	1438	
32	1/3/45	810104	1438	
40	1/3/45	810105	1904	
50	1/3/45	810106	2088	
63	1/3/45	810107	2088	

**Caretron™ ISOLATOR**

- Conforms to IEC 60947-3 • Bi-Connect Terminals • Positive Isolation
- Degree of Protection IP 20 • 25 sq. mm Terminals

**DOUBLE POLE**

**HSN Code: 8536**

	Rating (A)	Pack	Cat. Nos.	Unit Price (₹)
	40	1/6/90	810130	450
63	1/6/90	810131	560	

**THREE POLE**

**HSN Code: 8536**

	Rating (A)	Pack	Cat. Nos.	Unit Price (₹)
	40	1/4/60	810132	820
63	1/4/60	810133	924	

**FOUR POLE**

**HSN Code: 8536**

	Rating (A)	Pack	Cat. Nos.	Unit Price (₹)
	40	1/3/45	810134	1008
63	1/3/45	810135	1058	

**Caretron™ RESIDUAL CURRENT CIRCUIT BREAKER - RCCB**

- ISI / CE Marked as per IS/IEC 12640 -1 • Rated Conditional Short Circuit Current, Inc 6kA
- Degree of Protection IP 20 • Bi-Connect Terminals • 25 sq. mm Terminals

**DOUBLE POLE**

**HSN Code: 8536**

	Rating (A)	Sensitivity	Pack	Cat. Nos.	Unit Price (₹)
	25	30 mA	1/6/90	810150	2514
25	100 mA	1/6/90	810153	2566	
25	300 mA	1/6/90	810156	2566	
40	30 mA	1/6/90	810151	2768	
40	100 mA	1/6/90	810154	2792	
40	300 mA	1/6/90	810157	2792	
63	30 mA	1/6/90	810152	3514	
63	100 mA	1/6/90	810155	3544	
63	300 mA	1/6/90	810158	3544	

**FOUR POLE**

**HSN Code: 8536**

	Rating (A)	Sensitivity	Pack	Cat. Nos.	Unit Price (₹)
	25	30 mA	1/3/45	810159	3226
25	100 mA	1/3/45	810162	3266	
25	300 mA	1/3/45	810165	3266	
40	30 mA	1/3/45	810160	3278	
40	100 mA	1/3/45	810163	3318	
40	300 mA	1/3/45	810166	3318	
63	30 mA	1/3/45	810161	3728	
63	100 mA	1/3/45	810164	3782	
63	300 mA	1/3/45	810167	3782	

—optipro— **MINIATURE CIRCUIT BREAKER - MCB**

- ISI / CE Marked as per IS/IEC 60898 - 1 • Rated Short-Circuit Breaking Capacity, Icn 10kA • Degree of Protection IP 20
- Energy Limitation Class 3 • Line Load Reversibility • 35 sq. mm Terminals • Biconnect Terminals • Frequency: 50 Hz
- Operating Voltage : 240V / 415V AC , 60V DC per pole

**B CURVE SINGLE POLE**

HSN Code: 8536

	Rating (A)	Pack	Cat. Nos.	Unit Price (₹)
	6	1/12/180	811008	238
10	1/12/180	811010	238	
16	1/12/180	811012	238	
20	1/12/180	811013	238	
25	1/12/180	811014	238	
32	1/12/180	811015	238	
40	1/12/180	811016	536	
50	1/12/180	811017	624	
63	1/12/180	811018	624	

**B CURVE SINGLE POLE NEUTRAL**

HSN Code: 8536

	Rating (A)	Pack	Cat. Nos.	Unit Price (₹)
	6	1/6/90	811027	756
10	1/6/90	811029	756	
16	1/6/90	811031	756	
20	1/6/90	811032	756	
25	1/6/90	811033	756	
32	1/6/90	811034	756	
40	1/6/90	811035	1046	
50	1/6/90	811036	1194	
63	1/6/90	811037	1194	

**B CURVE DOUBLE POLE**

HSN Code: 8536

	Rating (A)	Pack	Cat. Nos.	Unit Price (₹)
	6	1/6/90	811046	788
10	1/6/90	811048	788	
16	1/6/90	811050	788	
20	1/6/90	811051	788	
25	1/6/90	811052	788	
32	1/6/90	811053	788	
40	1/6/90	811054	1136	
50	1/6/90	811055	1266	
63	1/6/90	811056	1266	

—optipro— **ISOLATOR**

- Conforms to IEC 60947-3 • CE Marked • Degree of Protection IP 20 • 35 sq. mm Terminals • Biconnect Terminals
- Frequency: 50 Hz • Operating Voltage: 240V/415V AC, 60V DC per Pole

**DOUBLE POLE**

HSN Code: 8536

	Rating (A)	Pack	Cat. Nos.	Unit Price (₹)
	80	1/6/90	811552	786
100	1/6/90	811553	786	
125	1/6/90	811554	848	

**THREE POLE**

HSN Code: 8536

	Rating (A)	Pack	Cat. Nos.	Unit Price (₹)
	80	1/4/60	811557	1190
100	1/4/60	811558	1190	
125	1/4/60	811559	1304	

**FOUR POLE**

HSN Code: 8536

	Rating (A)	Pack	Cat. Nos.	Unit Price (₹)
	80	1/3/45	811562	1478
100	1/3/45	811563	1478	
125	1/3/45	811564	1598	

**AUTOMATIC CHANGEOVER WITH CURRENT LIMITER**

- As per IEC60947-6-1
- Intelligent micro controller based Design
- RoHS Compliant

**HSN Code: 8536**

	Rating (A)	Pack	Cat. Nos.	Unit Price (₹)
	SPN 30A Mains 1.5A DG ACCL	1/3/45	810409	1772
	SPN 30A Mains 2.5A DG ACCL	1/3/45	810410	1772
	SPN 30A Mains 3A DG ACCL	1/3/45	810400	1772
	SPN 30A Mains 4A DG ACCL	1/3/45	810401	1772
	SPN 30A Mains 5A DG ACCL	1/3/45	810402	1772
	SPN 30A Mains 6A DG ACCL	1/3/45	810403	1772
	SPN 30A Mains 9A DG ACCL	1/3/45	810404	1772
	SPN 30A Mains 12A DG ACCL	1/3/45	810405	1772
	SPN 30A Mains 15A DG ACCL	1/3/45	810406	1772
	SPN 30A Mains 20A DG ACCL	1/3/45	810407	1772
	SPN 30A Mains 30A DG ACCL	1/3/45	810408	1772

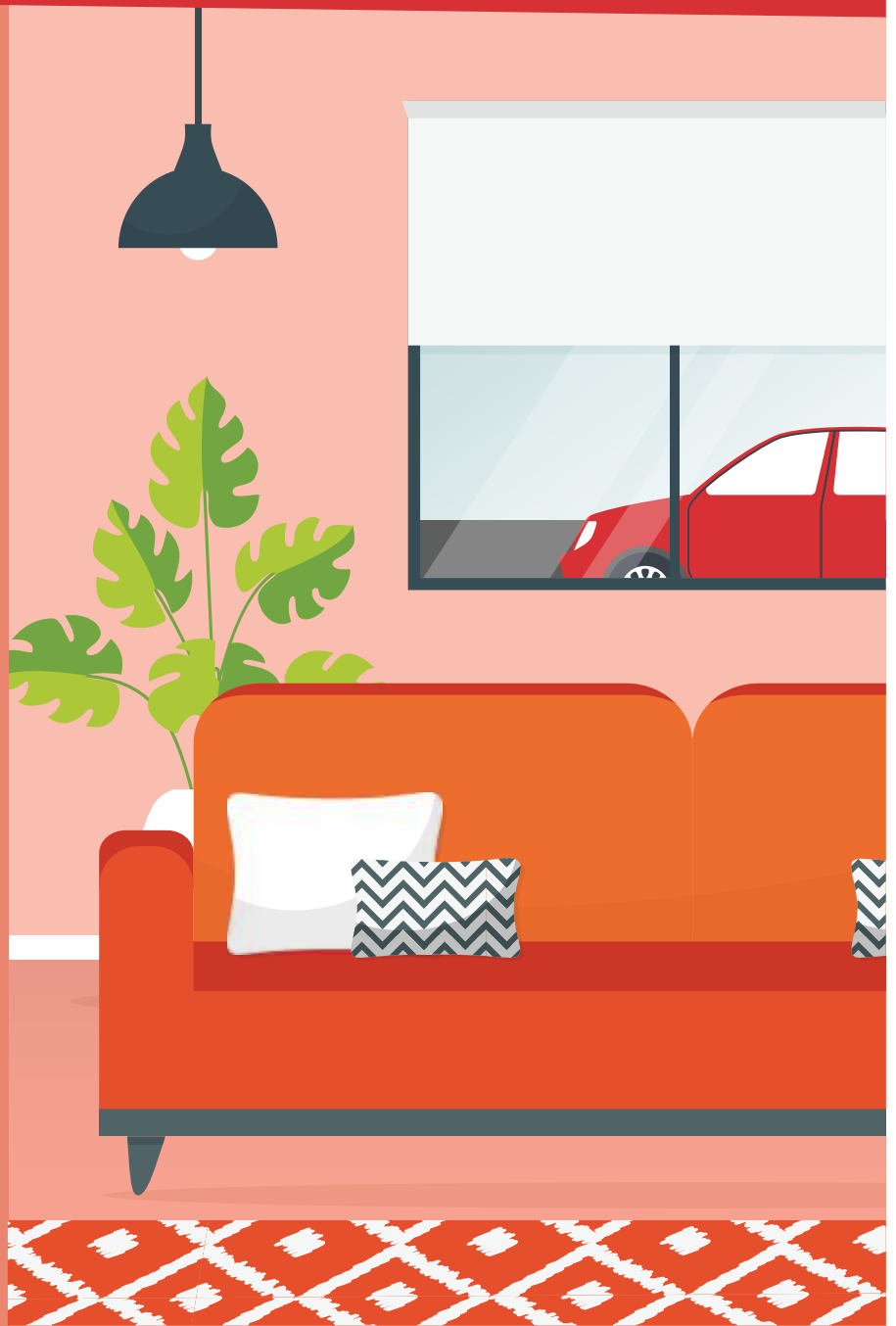

## RELIABILITY - SAFETY - ALL ROUND PROTECTION



Innovative design



Detachable Gland Plate



Degree of protection  
IP30 and IP 42



**Caretron™ DISTRIBUTION BOARDS**

- Innovative Design • Degree of Protection IP 30 & IP 42 • Detachable Gland Plate • Attractive Pearl Shade
- Box Insertion Marks • Circuit Identification Label • Neutral Link • Earth Link • Tin Plated Copper Bus Bar

**SPN SINGLE DOOR**

**HSN Code: 8537**

	No. of Way	Incomer+ Outgoing	Pack	Cat. Nos.	Unit Price (₹)
	4	4	1/19	810311	738
	6	6	1/18	810312	812
	8	8	1/13	810313	924
	12	12	1/11	810315	1260
	16	16	1/9	810316	1542

**SPN DOUBLE DOOR**

**HSN Code: 8537**

	No. of Way	Incomer+ Outgoing	Pack	Cat. Nos.	Unit Price (₹)
	4	4	1/14	810319	1208
	6	6	1/12	810320	1348
	8	8	1/10	810321	1500
	12	12	1/9	810323	1856
	16	16	1/7	810324	2250

**HSN Code: 8537**

**SPN ACRYLIC**

	No. of Way	Incomer+ Outgoing	Pack	Cat. Nos.	Unit Price (₹)
	4	4	1/12	810345	848
	6	6	1/12	810346	978
	8	8	1/8	810347	1152
	10	10	1/8	810348	1276
	12	12	1/8	810349	1418
	16	16	1/6	810350	2192

**TPN SINGLE DOOR**

**HSN Code: 8537**

	No. of Way	Incomer+ Outgoing	Pack	Cat. Nos.	Unit Price (₹)
	4	4 + 12	1/8	810327	2124
	4	8 + 12	1/8	810328	2272
	6	4 + 18	1/5	810329	2554
	6	8 + 18	1/5	810330	2840
	8	8 + 24	1/4	810331	3410
	12	8 + 36	1/4	810332	4594

**TPN DOUBLE DOOR**

**HSN Code: 8537**

	No. of Way	Incomer+ Outgoing	Pack	Cat. Nos.	Unit Price (₹)
	4	4 + 12	1/6	810336	2844
	4	8 + 12	1/6	810337	2954
	6	4 + 18	1/4	810338	3308
	6	8 + 18	1/4	810339	3528
	8	8 + 24	1/3	810340	4352
	12	8 + 36	1/3	810341	4930

**Caretron™ DISTRIBUTION BOARDS**

- Innovative Design • Degree of Protection IP 30 & IP 42 • Detachable Gland Plate • Attractive Pearl Shade
- Box Insertion Marks • Circuit Identification Label • Neutral Link • Earth Link • Tin Plated Copper Bus Bar

**VTPN MCB INCOMER SINGLE DOOR**

**HSN Code: 8537**

	No. of Way	Incomer+ Outgoing	Pack	Cat. Nos.	Unit Price (₹)
	4	8 + 12	1	810353	5784
	6	8 + 18	1	810354	6986
	8	8 + 24	1	810355	7986
	12	8 + 36	1	810356	9170

**VTPN MCB INCOMER DOUBLE DOOR**

**HSN Code: 8537**

	No. of Way	Incomer+ Outgoing	Pack	Cat. Nos.	Unit Price (₹)
	4	8 + 12	1	810359	7596
	6	8 + 18	1	810360	8900
	8	8 + 24	1	810361	9914
	12	8 + 36	1	810362	13104

**VTPN 125A MCCB I/C DD DB**

**HSN Code: 8537**

	No. of Way	Incomer+ Outgoing	Pack	Cat. Nos.	Unit Price (₹)
	4	Optium F1 + 12	1	810436	8254
	6	Optium F1 + 18	1	810437	9064
	8	Optium F1 + 24	1	810438	9534
	12	Optium F1 + 36	1	810439	11946

**VTPN 250A MCCB I/C DD DB**

**HSN Code: 8537**

	No. of Way	Incomer+ Outgoing	Pack	Cat. Nos.	Unit Price (₹)
	4	Optium F2 + 12	1	810446	10316
	6	Optium F2 + 18	1	810447	11336
	8	Optium F2 + 24	1	810448	11920
	12	Optium F2 + 36	1	810449	14936

**PHASE SELECTOR BARE SINGLE DOOR**

**HSN Code: 8537**

	No. of Way	Incomer+ Outgoing	Pack	Cat. Nos.	Unit Price (₹)
	4	8 + 12	1	810365	5260
	6	8 + 18	1	810366	5766
	8	8 + 24	1	810367	5858
	12	8 + 36	1	810368	7664

**PHASE SELECTOR BARE DOUBLE DOOR**

**HSN Code: 8537**

	No. of Way	Incomer+ Outgoing	Pack	Cat. Nos.	Unit Price (₹)
	4	8 + 12	1	810371	6550
	6	8 + 18	1	810372	6892
	8	8 + 24	1	810373	7360
	12	8 + 36	1	810374	8230

**PHASE SELECTOR 40A DOUBLE DOOR (PRE FITTED SELECTOR SWITCHES)**

**HSN Code: 8536**

	No. of Way	Incomer+ Outgoing	Pack	Cat. Nos.	Unit Price (₹)
	4	8 + 12	1	810375	8236
	6	8 + 18	1	810376	8950
	8	8 + 24	1	810377	9388
	12	8 + 36	1	810378	10732

**PHASE SELECTOR 63A DOUBLE DOOR (PRE FITTED SELECTOR SWITCHES)**

**HSN Code: 8536**

	No. of Way	Incomer+ Outgoing	Pack	Cat. Nos.	Unit Price (₹)
	4	8 + 12	1	810379	9808
	6	8 + 18	1	810380	10634
	8	8 + 24	1	810381	11106
	12	8 + 36	1	810382	12542

**PLUG & SOCKET BOX**

**HSN Code: 8536**

	No. of Way	Incomer+ Outgoing	Pack	Cat. Nos.	Unit Price (₹)
	20A SP (with 20A SP 'C' MCB)	1	1/24	810393	904
	20A DP (with 20A DP 'C' MCB)	2	1/24	810394	1208
	20A TP	3	1/8	810309	1944
	32A TP	3	1/8	810310	2708

**METAL ENCLOSURE**

**HSN Code: 8537**

	No. of Way	Incomer+ Outgoing	Pack	Cat. Nos.	Unit Price (₹)
	1	1	1/60	810302	346
	2	2	1/36	810303	346
	3	3	1/36	810304	404
	4	4	1/32	810305	404

**PLASTIC ENCLOSURE**

**HSN Code: 8536**

	No. of Way	Incomer+ Outgoing	Pack	Cat. Nos.	Unit Price (₹)
	1 & 2	1/2	1/5/45	810300	166
	3 & 4	3/4	1/3/27	810301	240

**BUSBAR CHAMBER  
COPPER TYPE**

**HSN Code: 8536**

	<p>Solution for safe Power Distribution</p> <ul style="list-style-type: none"> <li>• Step type design</li> <li>• Available in both SPN &amp; TPN configuration</li> </ul>	Item Description	Ingress Protection	Cat Ref.	Unit Price* (₹)
		Spl. 32A Busbar Chamber(Cu)	IP42	CPPI1015	5840
		Spl. 63A Busbar Chamber(Cu)	IP42	CPPI1016	6512
		Spl. 100A Busbar Chamber(Cu)	IP42	CPPI1017	7214
		Spl. 200A Busbar Chamber(Cu)	IP42	CPPI1018	8924
		Spl. 250A Busbar Chamber(Cu)	IP42	CPPI1019	12702
		Spl. 320A Busbar Chamber(Cu)	IP42	CPPI1020	15432
		Spl. 400A Busbar Chamber(Cu)	IP42	CPPI1021	17146
		Spl. 630A Busbar Chamber(Cu)	IP42	CPPI1022	27432

\*Contact branch office for IP54 design.

**BUSBAR CHAMBER  
ALUMINIUM TYPE**

**HSN Code: 8536**

	<p>Solution for safe Power Distribution</p> <ul style="list-style-type: none"> <li>• Step type design</li> <li>• Available in both SPN &amp; TPN configuration</li> </ul>	Item Description	Ingress Protection	Cat Ref.	Unit Price* (₹)
		Spl. 32ABusbar Chambe(Al.)	IP42	CPPI1023	5488
		Spl. 63ABusbar Chambe(Al.)	IP42	CPPI1024	5840
		Spl. 100ABusbar Chambe(Al.)	IP42	CPPI1025	6160
		Spl. 200ABusbar Chambe(Al.)	IP42	CPPI1026	6512
		Spl. 250ABusbar Chambe(Al.)	IP42	CPPI1027	7872
		Spl. 320ABusbar Chambe(Al.)	IP42	CPPI1028	8574
		Spl. 400ABusbar Chambe(Al.)	IP42	CPPI1029	8924
		Spl. 630ABusbar Chambe(Al.)	IP42	CPPI1008	15338

\*Contact branch office for IP54 design.

**MCCB ENCLOSURE**

**HSN Code: 8537**

	Description	Pack	Cat. Nos.	Unit Price (₹)
	Optipro Enclosure for Frame-1 Optium 3 Pole MCCB	1	811984	1474
	Optipro Enclosure for Frame-1 Optium 4 Pole MCCB	1	811985	1474
	Optipro Enclosure for Frame-2 Optium 3 Pole MCCB	1	811986	2264
	Optipro Enclosure for Frame-2 Optium 4 Pole MCCB	1	811987	2264
	Optipro Enclosure for Frame-3 Optium 3 Pole MCCB	1	811988	2264
	Optipro Enclosure for Frame-3 Optium 4 Pole MCCB	1	811989	2264
	Optipro Enclosure for Frame-4 Optium 3 Pole MCCB	1	811990	5662
	Optipro Enclosure for Frame-4 Optium 4 Pole MCCB	1	811991	5662

**METAL CLAD PLUG & SOCKET  
AC PLUG**

**HSN Code: 8536**

	Rating	Pack	Cat. Nos.	Unit Price (₹)
	10A 2P+E, 230V AC	1/10/100	810385	166
	20A 2P+E, 230V AC	1/10/100	810386	178
	20A 3P+E, 230V / 415V AC	1/10/100	810387	242
	32A 3P+E, 230V / 415V AC	1/10/100	810388	438

**AC SOCKET**

**HSN Code: 8536**

	Rating	Pack	Cat. Nos.	Unit Price (₹)
	10A 2P+E, 230V AC	1/10/100	810389	166
	20A 2P+E, 230V AC	1/10/100	810390	192
	20A 3P+E, 230V / 415V AC	1/10/100	810391	254
	32A 3P+E, 230V / 415V AC	1/10/100	810392	438

**TIME SWITCHES**

**HSN Code: 9107**

	Model Name	Description	Cat Ref.	Unit Price (₹)
	1mod DIN Daily	1P Module, 24 hours program, Programmable every 15 min., backup of 100 hours, current capacity 16A, with 1 changeover (1 CO)	TA916422	3184
	3mod DIN Daily	3P Module, 24 hours program, Programmable every 15 min., backup of 100 hrs., current capacity 16A, with 1 changeover (1 CO)	TA926453	3468
	DIN Type Daily / Weekly with 1 CO	Programmable every 1 min., with backup of 6 years, 28 memory locations, current capacity 16A, weekly program, with 1 changeover (1 CO), Total 28 program	TDA43110	4216

\* For other models of Time Switches please contact nearest Branch Office.

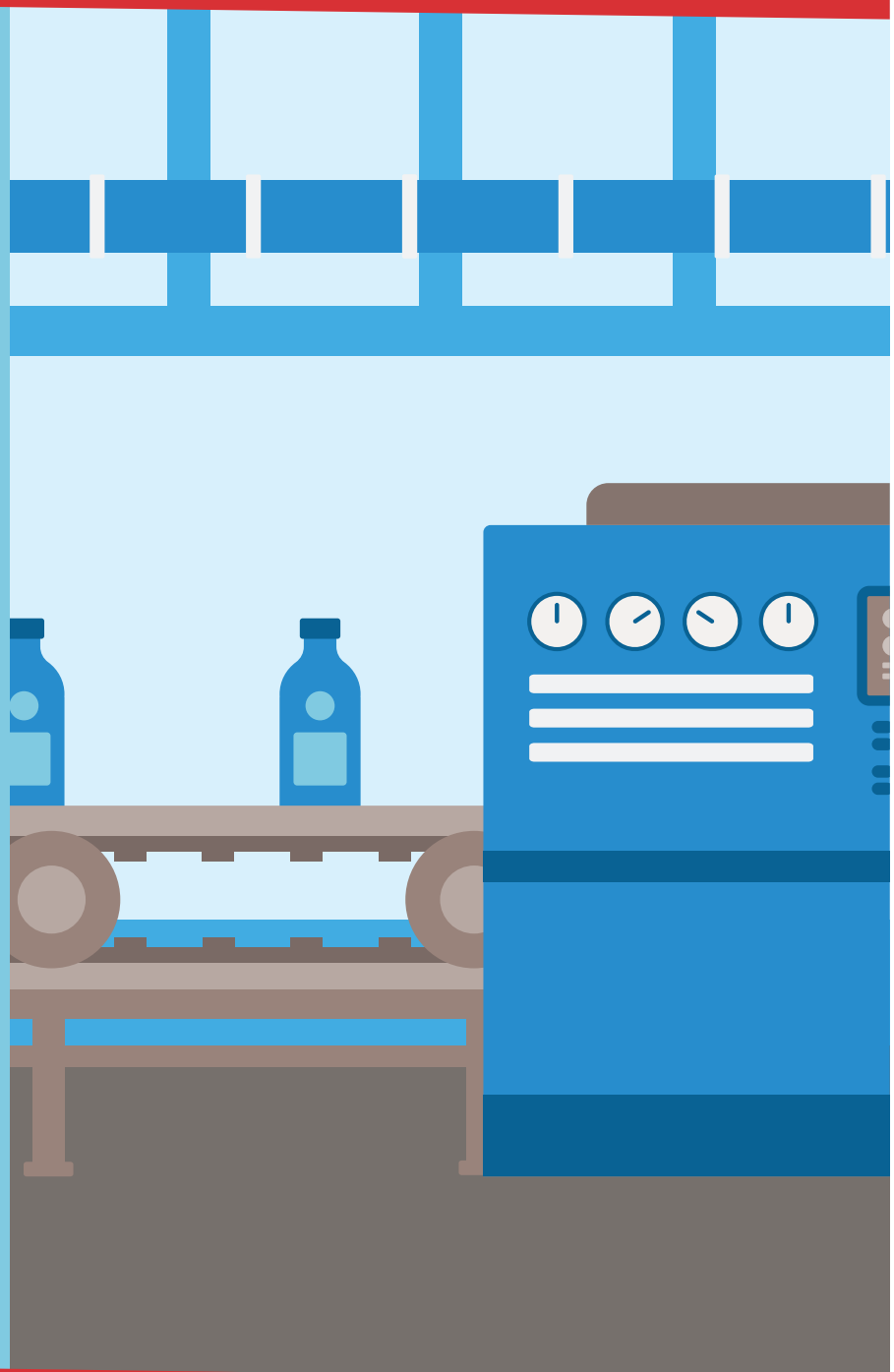

## COMPACT SIZE, SAFE TO USE



Wide range  
16A to 1250A



Overload short circuit &  
ground fault protection



Better clearance with  
copper spreaders

— optium™ —

ALL THAT YOU NEED

—optium™— **OPTIUM 1.0E (FIXED TM MCCB RANGE)**

- Ics =50% Icu as per IEC 60947-II
- Class II front face
- Suitable for isolation
- Fixed Overload & fixed short circuit setting

**HSN Code: 8536**

Image	Frame	Breaking capacity	Rating	3P	Unit Price (₹)	4P	Unit Price (₹)
		F1	10kA	16	830701	2168	830710
F1		10kA	25	830702	2168	830711	2764
F1		10kA	32	830703	2168	830712	2764
F1		10kA	40	830704	2168	830713	2764
F1		10kA	50	830705	2168	830714	2764
F1		10kA	63	830706	2168	830715	2764
F1		10kA	80	830707	2322	830716	3114
F1		10kA	100	830708	2322	830717	3114
F1		10kA	125	830709	3436	830718	4750

**HSN Code: 8536**

Image	Frame	Breaking capacity	Rating	3P	Unit Price (₹)	4P	Unit Price (₹)
		F1	16kA	16	830001	3818	830015
F1		16kA	25	830002	3818	830016	4662
F1		16kA	32	830003	3818	830017	4662
F1		16kA	40	830004	3818	830018	4662
F1		16kA	50	830005	3818	830019	4662
F1		16kA	63	830006	3818	830020	4662
F1		16kA	80	830007	3930	830021	5064
F1		16kA	100	830008	3930	830022	5064
F1		16kA	125	830009	5500	830023	7470

**HSN Code: 8536**

Image	Frame	Breaking capacity	Rating	3P	Unit Price (₹)	4P	Unit Price (₹)
		F1	25kA	16	830031	4700	830045
F1		25kA	25	830032	4700	830046	5728
F1		25kA	32	830033	4700	830047	5728
F1		25kA	40	830034	4700	830048	5728
F1		25kA	50	830035	4700	830049	5728
F1		25kA	63	830036	4700	830050	5728
F1		25kA	80	830037	4794	830051	5900
F1		25kA	100	830038	4794	830052	5900
F1		25kA	125	830039	5886	830053	7834

**HSN Code: 8536**

Image	Frame	Breaking capacity	Rating	3P	Unit Price (₹)	4P	Unit Price (₹)
		F1	36kA	16	830061	6164	830075
F1		36kA	25	830062	6164	830076	7188
F1		36kA	32	830063	6164	830077	7188
F1		36kA	40	830064	6164	830078	7188
F1		36kA	50	830065	6164	830079	7188
F1		36kA	63	830066	6164	830080	7188
F1		36kA	80	830067	6572	830081	7576
F1		36kA	100	830068	6572	830082	7576
F1		36kA	125	830069	7204	830083	9182

—optium™— **OPTIUM 1.0 (FIXED TM MCCB RANGE)**

**HSN Code: 8536**

	Frame	Breaking capacity	Rating	3P	Unit Price (₹)	4P	Unit Price (₹)
	F3	50kA	16	830125	8208	830145	9978
	F3	50kA	25	830126	8208	830146	9978
	F3	50kA	32	830127	8208	830147	9978
	F3	50kA	40	830128	8208	830148	9978
	F3	50kA	50	830129	8208	830149	9978
	F3	50kA	63	830130	8208	830150	9978
	F3	50kA	80	830131	8452	830151	10078
	F3	50kA	100	830132	8452	830152	10078
	F3	50kA	125	830133	9860	830153	11810

**HSN Code: 8536**

	Frame	Breaking capacity	Rating	3P	Unit Price (₹)	4P	Unit Price (₹)
	F2	16kA	160	830090	6218	830095	8602
	F2	16kA	200	830091	7676	830096	9992
	F2	16kA	250	830092	8470	830097	10554
	F2	25kA	160	830100	7468	830105	9866
	F2	25kA	200	830101	10240	830106	11474
	F2	25kA	250	830102	13818	830107	16658
	F2	36kA	160	830110	9496	830115	12226
	F2	36kA	200	830111	11278	830116	15090
	F2	36kA	250	830112	14300	830117	19344

**HSN Code: 8536**

	Frame	Breaking capacity	Rating	3P	Unit Price (₹)	4P	Unit Price (₹)
	F3	50kA	160	830134	10716	830154	14026
	F3	50kA	200	830135	12310	830155	17260
F3	50kA	250	830136	18730	830156	22684	

**HSN Code: 8536**

	Frame	Breaking capacity	Rating	3P	Unit Price (₹)	4P	Unit Price (₹)
	F4	36kA	315	830165	21436	830175	25946
	F4	36kA	400	830166	22656	830176	26882
	F4	36kA	500	830167	25352	830177	30514
F4	36kA	630	830168	26872	830178	32760	

**HSN Code: 8536**

	Frame	Breaking capacity	Rating	3P	Unit Price (₹)	4P	Unit Price (₹)
	F4	50kA	315	830185	22510	830195	26688
	F4	50kA	400	830186	24568	830196	29392
	F4	50kA	500	830187	25932	830197	31284
F4	50kA	630	830188	28590	830198	33388	

**HSN Code: 8536**

	Frame	Breaking capacity	Rating	3P	MRP	4P	MRP
F5	50kA	800	830200	35848	830201	45846	

—optium™— **OPTIUM 1.1 (FIXED TM MCCB RANGE)**

- Ics = 100% Icu as per IEC 60947-II
- Suitable for isolation
- Class II front face
- Fixed Overload & fixed short circuit setting

**HSN Code: 8536**



Frame	Breaking capacity	Rating	3P	Unit Price (₹)	4P	Unit Price (₹)
F1	16kA	32	840003	3954	840017	5292
F1	16kA	40	840004	3954	840018	5292
F1	16kA	63	840006	3954	840020	5292
F1	16kA	80	840007	4032	840021	5550
F1	16kA	100	840008	4032	840022	5550
F1	16kA	125	840009	5710	840023	7746
F1	25kA	32	840033	5034	840047	6136
F1	25kA	40	840034	5034	840048	6136
F1	25kA	63	840036	5034	840050	6136
F1	25kA	80	840037	5180	840051	6254
F1	25kA	100	840038	5180	840052	6254
F1	25kA	125	840039	6286	840053	8772
F2	16kA	160	840090	6006	840095	9486
F2	16kA	200	840091	7910	840096	10602
F2	16kA	250	840092	9016	840097	12154
F2	25kA	160	840100	7696	840105	10564
F2	25kA	200	840101	10484	840106	13480
F2	25kA	250	840102	14500	840107	17594

—optium™— **OPTIUM 2.0 (ADJUSTABLE THERMAL SETTING MCCB)**

- Conforms to IEC 60947-II
- Adjustable Overload Setting Ir = (0.8 to 1.0)In
- Ics = 100% Icu
- Class II front face
- Short Circuit setting fixed
- Suitable for isolation

**HSN Code: 8536**



Frame	Breaking capacity	Rating	3P	Unit Price (₹)	4P	Unit Price (₹)
F1	16kA	25	830222	4218	830236	5580
F1	16kA	32	830223	4218	830237	5580
F1	16kA	40	830224	4218	830238	5580
F1	16kA	50	830225	4218	830239	5580
F1	16kA	63	830226	4218	830240	5580
F1	16kA	80	830227	4756	830241	6236
F1	16kA	100	830228	4756	830242	6236
F1	16kA	125	830229	6008	830243	8198

**HSN Code: 8536**



Frame	Breaking capacity	Rating	3P	Unit Price (₹)	4P	Unit Price (₹)
F1	25kA	25	830252	5188	830266	6412
F1	25kA	32	830253	5188	830267	6412
F1	25kA	40	830254	5188	830268	6412
F1	25kA	50	830255	5188	830269	6412
F1	25kA	63	830256	5188	830270	6412
F1	25kA	80	830257	5340	830271	6726
F1	25kA	100	830258	5340	830272	6726
F1	25kA	125	830259	6550	830273	8282

**HSN Code: 8536**



Frame	Breaking capacity	Rating	3P	Unit Price (₹)	4P	Unit Price (₹)
F2	16kA	160	830280	6314	830285	9064
F2	16kA	200	830281	8388	830286	10596
F2	16kA	250	830282	10390	830287	13308
F2	25kA	160	830290	8524	830295	11294
F2	25kA	200	830291	10502	830296	14078
F2	25kA	250	830292	13738	830297	15632



—optium™— **OPTIUM 2.0 (ADJUSTABLE TM MCCB RANGE)**

- Ics =100% Icu as per IEC 60947-II
- Adjustable Overload Setting Ir =(0.8 to 1.0)xIn
- Class II front face
- Adjustable Short Circuit Setting Isd =(5 -10)xIn
- Suitable for isolation

**HSN Code: 8536**

	Frame	Breaking capacity	Rating	3P	Unit Price (₹)	4P	Unit Price (₹)
	F3	36kA	16	830305	6588	830325	9358
F3	36kA	25	830306	6588	830326	9358	
F3	36kA	32	830307	6588	830327	9358	
F3	36kA	40	830308	6588	830328	9358	
F3	36kA	50	830309	6588	830329	9358	
F3	36kA	63	830310	6588	830330	9358	
F3	36kA	80	830311	6716	830331	9632	
F3	36kA	100	830312	6716	830332	9632	
F3	36kA	125	830313	8296	830333	10792	

**HSN Code: 8536**

	Frame	Breaking capacity	Rating	3P	Unit Price (₹)	4P	Unit Price (₹)
	F3	50kA	16	830345	9352	830365	10498
F3	50kA	25	830346	9352	830366	10498	
F3	50kA	32	830347	9352	830367	10498	
F3	50kA	40	830348	9352	830368	10498	
F3	50kA	50	830349	9352	830369	10498	
F3	50kA	63	830350	9352	830370	10498	
F3	50kA	80	830351	9540	830371	10602	
F3	50kA	100	830352	9540	830372	10602	
F3	50kA	125	830353	10498	830373	12656	

**HSN Code: 8536**

	Frame	Breaking capacity	Rating	3P	Unit Price (₹)	4P	Unit Price (₹)
	F3	36kA	160	830314	10898	830334	13328
F3	36kA	200	830315	12220	830335	17390	
F3	36kA	250	830316	16050	830336	22772	

**HSN Code: 8536**

	Frame	Breaking capacity	Rating	3P	Unit Price (₹)	4P	Unit Price (₹)
	F3	50kA	160	830354	12026	830374	14244
F3	50kA	200	830355	14030	830375	18064	
F3	50kA	250	830356	19914	830376	23336	

**HSN Code: 8536**

	Frame	Breaking capacity	Rating	3P	Unit Price (₹)	4P	Unit Price (₹)
	F4	25kA	315	830385	19630	830387	22890
F4	25kA	400	830386	20098	830388	24972	
F4	36kA	315	830390	21444	830395	25906	
F4	36kA	400	830391	22812	830396	27892	
F4	36kA	500	830392	27122	830397	33026	
F4	36kA	630	830393	29466	830398	36994	
F4	50kA	315	830400	23320	830405	28332	
F4	50kA	400	830401	24890	830406	29752	
F4	50kA	500	830402	28512	830407	34882	
F4	50kA	630	830403	30824	830408	38698	

—optium™— **OPTIUM 2.0 (ADJUSTABLE TM MCCB RANGE)**

**HSN Code: 8536**

Frame	Breaking capacity	Rating	3P	Unit Price (₹)	4P	Unit Price (₹)
F5	36kA	800	830410	36618	830413	42094
F5	36kA	1000	830411	52734	830414	56552
F5	36kA	1250	830412	60992	830415	67956
F5	50kA	800	830416	38428	830419	53260
F5	50kA	1000	830417	66832	830420	69714
F5	50kA	1250	830418	73708	830421	80748

—optium™— **ACCESSORIES**

**HSN Code: 8538**

Product	Frame	Cat Ref.	Unit Price (₹)
Auxiliary contact	F1 F2 F3	830691	874
Alarm Contact	F1 F2 F3	830692	874
Auxiliary contact / Alarm Contact	F4-F5	830693	1146
Auxiliary contact / Alarm Contact	F1 F2 F3	830694	1310

**HSN Code: 8538**

Product	Frame	Cat Ref.	Unit Price (₹)
"Shunt trip 24 V AC/DC"	F1 F2 F3	830602	1060
"Shunt trip 110 V AC/DC"	F1 F2 F3	830603	1060
"Shunt trip 230 V AC/DC"	F1 F2 F3	830604	1060
"Shunt trip 415 V AC/DC"	F1 F2 F3	830605	1060
"Shunt trip 24 V AC/DC"	F4 F5	830642	1946
"Shunt trip 110 V AC/DC"	F4 F5	830643	1946
"Shunt trip 230 V AC/DC"	F4 F5	830644	1946
"Shunt trip 415 V AC/DC"	F4 F5	830645	1946

**HSN Code: 8538**

Product	Frame	Cat Ref.	Unit Price (₹)
"Undervoltage 24 V DC"	F1 F2 F3	830606	1624
"Undervoltage 110V AC"	F1 F2 F3	830607	1624
"Undervoltage 230V AC"	F1 F2 F3	830608	1624
"Undervoltage 415V AC"	F1 F2 F3	830609	1624
"Undervoltage 24 V DC"	F4 F5	830646	1730
"Undervoltage 110V AC"	F4 F5	830647	1730
"Undervoltage 230V AC"	F4 F5	830648	1730
"Undervoltage 415V AC"	F4 F5	830649	1730

**HSN Code: 8538**

Product	Frame	Cat Ref.	Unit Price (₹)
Rotary Handle Direct	F1	830611	1244
Rotary Handle vary-Depth	F1	830612	1244
Rotary Handle Direct	F2 F3	830626	1460
Rotary Handle vary-Depth	F2 F3	830627	1460
Rotary Handle Direct	F4	830651	1730
Rotary Handle vary-Depth	F4	830652	1730
Rotary Handle Direct	F5	830671	3388
Rotary Handle vary-Depth	F5	830672	3388

—optium™— **ACCESSORIES**

**HSN Code: 8538**

	Product	Frame	Cat Ref.	Unit Price (₹)
	Ronis lock Direct RH	F1 F2 F3	830613	1458
	Ronis lock Vary-Depth RH	F1 F2 F3	830614	1458
	Ronis lock Vary-Depth RH	F4	830653	1966

**HSN Code: 8538**

	Product	Frame	Cat Ref.	Unit Price (₹)
	Padlock Off position	F1 F2 F3	830615	1986
	Padlock Off position	F4	830654	1986
	Padlock Off position	F5	830674	1986

**HSN Code: 8538**

	Product	Frame	Cat Ref.	Unit Price (₹)
	Phase insulators 3P	F1 F2	830616	POR
	Phase insulators 3P	F3	830628	POR
	Phase insulators 3P	F4	830655	POR
	Phase insulators 3P	F5	830675	POR
	Phase insulators 4P	F1 F2	830617	POR
	Phase insulators 4P	F3	830629	POR
	Phase insulators 4P	F4	830656	POR
	Phase insulators 4P	F5	830676	POR

**HSN Code: 8538**

	Product	Frame	Cat Ref.	Unit Price (₹)
	Spreaders 3P	F1	830618	358
	Spreaders 4P	F1	830619	522
	Spreaders 3P	F2 F3	830632	954
	Spreaders 4P	F2 F3	830633	1906
	Spreaders 3P	F4	830659	3050
	Spreaders 4P	F4	830660	4448
	Spreaders 3P 800/1000A	F5	830681	7880
	Spreaders 4P 800/1000A	F5	830682	11554
	Spreaders 3P 1250A	F5	830685	8194
	Spreaders 4P 1250A	F5	830686	12080

**HRC FUSE LINKS & BASES**

**BOLTED TYPE (BS) BREAKING CAPACITY ≥ 80kA 500 V AC 50 Hz.**

**HSN Code: 8536**

	Rating	Type	Cat Ref.	Tag Type	Unit Price (₹)	Unit/Carton
		2, 4, 6, 8, 10, 16A	FGN	IEFGN***	Offset	70
	20, 25, 32A	FGN	IEFGN***	Offset	78	20
	2, 4, 6, 10, 16, 20, 25, 32A	FSA	IEFSA***	Offset	106	10
	35, 40, 50, 63A	FSS	IEFSS***	Offset	118	10
	50, 63, 80, 100, 125, 160A	FSDCP	IEDCP***	Offset	250	10
	100, 125, 160, 200, 250A	FSFP	IESFP***	Offset	360	3
	50, 63, 80, 100, 125A	FSDC	IESDC***	Central	250	10
	100, 125, 160, 200, 250A	FSF	IEFSF***	Central	368	3
	225, 250, 300, 315, 320A	FSK	IEFSK***	Central	532	3
	355, 400A	FMF	IEFMF***	Central	1028	3
	355, 400, 450, 500, 560, 600, 630A	FTS	IEFTS***	Central	1186	1
	355, 400, 450, 500, 560A	FTM	IEFTM***	2 Central	1544	1
	600, 630A	FTM	IEFTM***	2 Central	2106	1

**DIN TYPE BREAKING CAPACITY ≥ 80kA 500 V AC 50 Hz.**

**HSN Code: 8536**

	Rating Amps	Type	Cat Ref.	Unit Price (₹)	Unit/Carton
		2, 4, 6, 10, 16, 20, 25, 32, 50, 63A	Size 000	IWS00***	290
	2, 4, 6, 10, 16, 20, 25, 32, 36, 40, 50, 63A	Size 00	IW000***	334	6
	80, 100A		IW000***	348	6
	125, 160A		IW000***	370	6
	32, 36, 50, 63, 80, 100, 125, 160, 200A	Size 01	IW001***	610	3
	250A		IW001***	694	3
	100, 125, 200, 250, 315A	Size 02	IW002***	896	3
	400A		IW002***	970	3
	315, 355, 400, 425A	Size 03	IW003***	1230	3
	500, 630A		IW003***	1432	3

\* Note HRC fuses with SC breaking capacity 120kA are available on request.

**CYLINDRICAL TYPE (IFRH) BREAKING CAPACITY > 80kA 415 V AC.**

**HSN Code: 8536**

	Rating	Cat Ref.	Unit Price (₹)
		2 to 25A	IFRHO***
	32 to 40A	IFRHO***	140
	50A	IFRH0050	258
	63A	IFRH0063	264
	Fuse Holder Fr type (2 to 63A)	IFR00***	246

**FUSE FITTINGS FOR BOLTED (BS) TYPE**

**HSN Code: 8536**

	Rating	Front Connection	Unit Price (₹)	Back Busbar Connection	Unit Price (₹)	Unit/Carton
		20A	BFFC 0020	150	BFBC 0020	162
	32A	BFFC 0032	262	BFBC 0032	274	10
	63A	BFFC 0063	378	BFBC 0063	398	5
	100A	BFFC 0100	974	BFBC 0100	1002	3
	20A (Stud Type)			BFCS 020	218	1



**FUSE BASES FOR DIN TYPE HRC FUSE LINKS**

**HSN Code: 8536**

	Rating Amps	Suitable for	Cat Ref.	Unit Price (₹)	Unit/Carton
		6-160A	Size - 00	IWFB0***	428
	32-250A	Size - 1	IWFB1***	818	2
	100-400A	Size - 2	IWFB2***	1222	2
	315-630A	Size - 3	IWFB3***	1550	2



**SWITCH DISCONNECTOR FUSES**

**HSN Code: 8536**

Rated Current	Type	IN OPEN EXECUTION*		IN SHEET STEEL ENCLOSURE		Recommended HRC Fuse Indo Asian Make	
		Cat Ref.	Unit Price (₹)	Cat Ref.	Unit Price (₹)		
	32A BS	TPN	INO1A032	1808	INS1A032	3546	FSA
	63A BS	TPN	INO1A063	2500	INS1A063	4520	FSS
	100A BS	TPN	INO1A100	5496	INS1A100	7688	FSDCP
	125A BS	TPN	INO1A125	5878	INS1A125	8864	FSDCP
	160A BS	TPN	INO1A160	7116	INS1A160	9898	FSDCP
	200A BS	TPN	INO1A200	8852	INS1A200	11968	FSF
	250A BS	TPN	INO1A250	9994	INS1A250	13434	FSF
	315A BS	TPN	INO1A315	12808	INS1A315	16774	FSK
	400A BS	TPN	INO1A400	15896	INS1A400	20024	FMF
	32A BS	TPSN	INO1B032	2296	INS1B032	3962	FSA
	63A BS	TPSN	INO1B063	2916	INS1B063	4688	FSS
	100A BS	TPSN	INO1B100	6758	INS1B100	8772	FSDCP
	125A BS	TPSN	INO1B125	7400	INS1B125	9388	FSDCP
	160A BS	TPSN	INO1B160	9256	INS1B160	12134	FSDCP
	200A BS	TPSN	INO1B200	10542	INS1B200	13682	FSF
	250A BS	TPSN	INO1B250	11494	INS1B250	14932	FSF
	315A BS	TPSN	INO1B315	16264	INS1B315	21462	FSK
	400A BS	TPSN	INO1B400	19240	INS1B400	22986	FMF

\* Price Does Not Include HRC Fuse

**HSN Code: 8536**

Rated Current	Type	IN OPEN EXECUTION*		IN SHEET STEEL ENCLOSURE		Recommended HRC Fuse Indo Asian Make	
		Cat Ref.	Unit Price (₹)	Cat Ref.	Unit Price (₹)		
	32A DIN	TPN	IN10A032	1898	IN1SA032	3510	Size 000
	63A DIN	TPN	IN10A063	2634	IN1SA063	4462	Size 000
	100A DIN	TPN	IN10A100	5634	IN1SA100	7604	Size 00
	125A DIN	TPN	IN10A125	6026	IN1SA125	8838	Size 00
	160A DIN	TPN	IN10A160	7252	IN1SA160	9710	Size 00
	200A DIN	TPN	IN10A200	9136	IN1SA200	11052	Size 01
	250A DIN	TPN	IN10A250	10142	IN1SA250	13302	Size 01
	315A DIN	TPN	IN10A315	13266	IN1SA315	16560	Size 02
	400A DIN	TPN	IN10A400	16352	IN1SA400	19630	Size 02
	630A DIN	TPN	IN10A630	27022	IN1SA630	29102	Size 03
	800A DIN	TPN	IN10A800	32948	IN1SA800	41196	Size 03
	32A DIN	TPSN	IN10B032	2520	IN1SB032	3612	Size 000
	63A DIN	TPSN	IN10B063	2904	IN1SB063	3900	Size 000
	100A DIN	TPSN	IN10B100	6508	IN1SB100	7778	Size 00
	125A DIN	TPSN	IN10B125	7210	IN1SB125	8372	Size 00
	160A DIN	TPSN	IN10B160	8448	IN1SB160	11194	Size 00
	200A DIN	TPSN	IN10B200	9818	IN1SB200	11808	Size 01
	250A DIN	TPSN	IN10B250	11244	IN1SB250	13528	Size 01
	315A DIN	TPSN	IN10B315	15050	IN1SB315	18408	Size 02
	400A DIN	TPSN	IN10B400	17490	IN1SB400	22986	Size 02
	630A DIN	TPSN	IN10B630	28078	IN1SB630	31438	Size 03
	800A DIN	TPSN	IN10B800	33670	IN1SB800	45314	Size 03

\* Price Does Not Include HRC Fuse

**SWITCH DISCONNECTOR 4 POLE**

HSN Code: 8536

Rated Current	IN OPEN EXECUTION*		IN SHEET STEEL ENCLOSURE	
	Cat Ref.	Unit Price (₹)	Cat Ref.	Unit Price (₹)
32A	IN1SD032	2462	IN1ED032	3386
63A	IN1SD063	2874	IN1ED063	4000
100A	IN1SD100	4182	IN1ED100	7266
125A	IN1SD125	6106	IN1ED125	8246
160A	IN1SD160	6878	IN1ED160	9848
200A	IN1SD200	9278	IN2ED200	11956
250A	IN1SD250	10110	IN2ED250	15772
315A	IN1SD315	12644	IN3ED315	17238
400A	IN1SD400	15334	IN3ED400	20212
630A	IN1SD630	23356	IN4ED630	29486
800A	IN1SD800	27818	IN4ED800	34798

\*Prices of 3 Pole SD is available on Request.

**Ambidex CHANGEOVER SWITCHES  
ON-LOAD CHANGEOVER SWITCHES 4 POLE**

HSN Code: 8536

Rated Current	IN OPEN EXECUTION		IN SHEET STEEL ENCLOSURE	
	Cat Ref.	Unit Price (₹)	Cat Ref.	Unit Price (₹)
63A	ITAE0063	4824	ITAS0063	7036
100A	ITAE0100	6402	ITAS0100	9338
125A	ICAE0125	9592	ICAS0125	13990
160A	ICAE0160	10550	ICAS0160	15386
200A	ICAE0200	12684	ICAS0200	18496
250A	ICAE0250	15506	ICAS0250	22610
320A	ICAE0320	20330	ICAS0320	29650
400A	ICAE0400	29502	ICAS0400	43022
630A	ICAE0630	35090	ICAS0630	51172
800A	ITAE0800	50894	ITAS0800	74224
1000A	ITAE1000	84464	ITAS1000	123178
1250A	ITAE1250	115476	ITAS1250	168404
1600A	ITAE1600	159414	ITAS1600	232478
2000A	ITAE2000	203596	ITAS2000	267220
2500A	ITAE2500	272466	ITAS2500	357614
3150A	ITAE3150	291940	ITAS3150	454104

HSN Code: 8536

ACCESSORIES FOR AMBIDEX CHANGEOVER SWITCHES	Cat Ref.	Unit Price (₹)
Auxiliary Switch 200A-630A (1NO + 1NC)	ICA00AUX	210
Spreader Links for Frame00 - 1 set (4 links)	ICA00SPL	350

**ON-LOAD SWITCH FUSE CHANGEOVER**

HSN Code: 8536

Rated Current	IN OPEN EXECUTION		IN SHEET STEEL ENCLOSURE		Recommended HRC Fuse Indo Asian Make
	Cat Ref.	Unit Price (₹)	Cat Ref.	Unit Price (₹)	
125A	ITBE0125	13732	ITBS0125	20986	FSDCP
200A	ITBE0200	25088	ITBS0200	37248	FSF
250A	ITBE0250	25324	ITBS0250	37594	FSK
320A	ITBE0320	26146	ITBS0320	38818	FSK
400A	ITBE0400	37502	ITBS0400	55678	FTS
630A	ITBE0630	43768	ITBS0630	64984	FTS

Price does not include HRC Fuses.

**ON-LOAD BY-PASS SWITCHES**

HSN Code: 8536

Rated Current	IN OPEN EXECUTION		IN SHEET STEEL ENCLOSURE	
	Cat Ref.	Unit Price (₹)	Cat Ref.	Unit Price (₹)
125A	ITCE0125	17992	ITCS0125	24294
200A	ITCE0200	22912	ITCS0200	30930
250A	ITCE0250	33282	ITCS0250	44932
320A	ITCE0320	34558	ITCS0320	46656
400A	ITCE0400	51838	ITCS0400	69984
630A	ITCE0630	58894	ITCS0630	79510

**REWIRABLE SWITCH FUSE UNIT**

**HSN Code: 8537**

 <ul style="list-style-type: none"> <li>• Single Pole &amp; Neutral/Double Pole 240/415 VAC 50 Hz</li> <li>• Conforms to IS/IEC 13947-3</li> </ul>	Rating	Type	Cat Ref.	Rated Voltage	Unit Price* (₹)
	16A	SPN	RCSPN016	240 V	718
	32A	SPN	RCSPN032	240 V	1732
	16A	DP	RCDP0016	240 V	758
	32A	DP	RCDP0032	240 V	1780
	32A	DP	#DDP0032	415 V	2446
	63A	DP	#DDP0063	415 V	4586

# For Rewirable type carrier, prefix R, for HRC type carrier, prefix H.  
\* These prices are without wire & HRC.

**COMBINATION FUSE SWITCH**

**HSN Code: 8536**

 <ul style="list-style-type: none"> <li>• Double Break in Sheet steel enclosure</li> <li>• Conforms to IS/IEC 13947-3</li> <li>• Rated Voltage - 415V AC 50 Hz</li> <li>• Type - TPN</li> </ul>	Rating	HRC Fuse Type	Cat Ref.	Unit Price* (₹)
	63A	FSS	DDTPN063	8688
	100A	FSDCP	DDTPN100	11666
	200A	FSF	DDTPN200	17366
	300A	FSK	DDTPN300	21908
	400A	FTS	DDTPN400	31780

\* These prices are without HRC.

**TRIPLE POLE NEUTRAL HRC TYPE  
REWIRABLE SWITCH FUSE UNIT**

**HSN Code: 8537 H  
HSN Code: 8536 R**

 <ul style="list-style-type: none"> <li>• Rated Voltage - 415V-AC 50Hz</li> <li>• Type - TPN</li> </ul>	Rating	HRC Fuse Type	Cat Ref.	Unit Price* (₹)
	16A	FSA	#DTPN016	2096
	32A	FSA	#DTPN032	2820
	63A	FSS	#DTPN063	6004
	100A	FSDCP	#DTPN100	10952

# For Rewirable type carrier, prefix R, for HRC type carrier, prefix H.  
\* These prices are without wire & HRC.

**OFF LOAD CHANGEOVER SWITCH**

**HSN Code: 8536**

 <ul style="list-style-type: none"> <li>• With enclosure</li> <li>• Rated Voltage - 415V-AC 50Hz</li> <li>• Type - FP</li> </ul>	Rating	Cat Ref.	Unit Price (₹)
	32A (DP)	OFDP0032	1708
	16A	OFFP0016	2734
	32A	OFFP0032	2852
	63A	OFFP0063	5798
	100A	OFFP0100	11334
	125A	OFFP0125	15932
	200A	OFFP0200	17200
	250A	OFFP0250	21912
	315A	OFFP0315	22620
	400A	OFFP0400	26388

Prices for spares of Rewirable Switch Fuse Unit like Action Bar, Base Plate, End Shield, Bakelite Contact Shrouds are available on request.

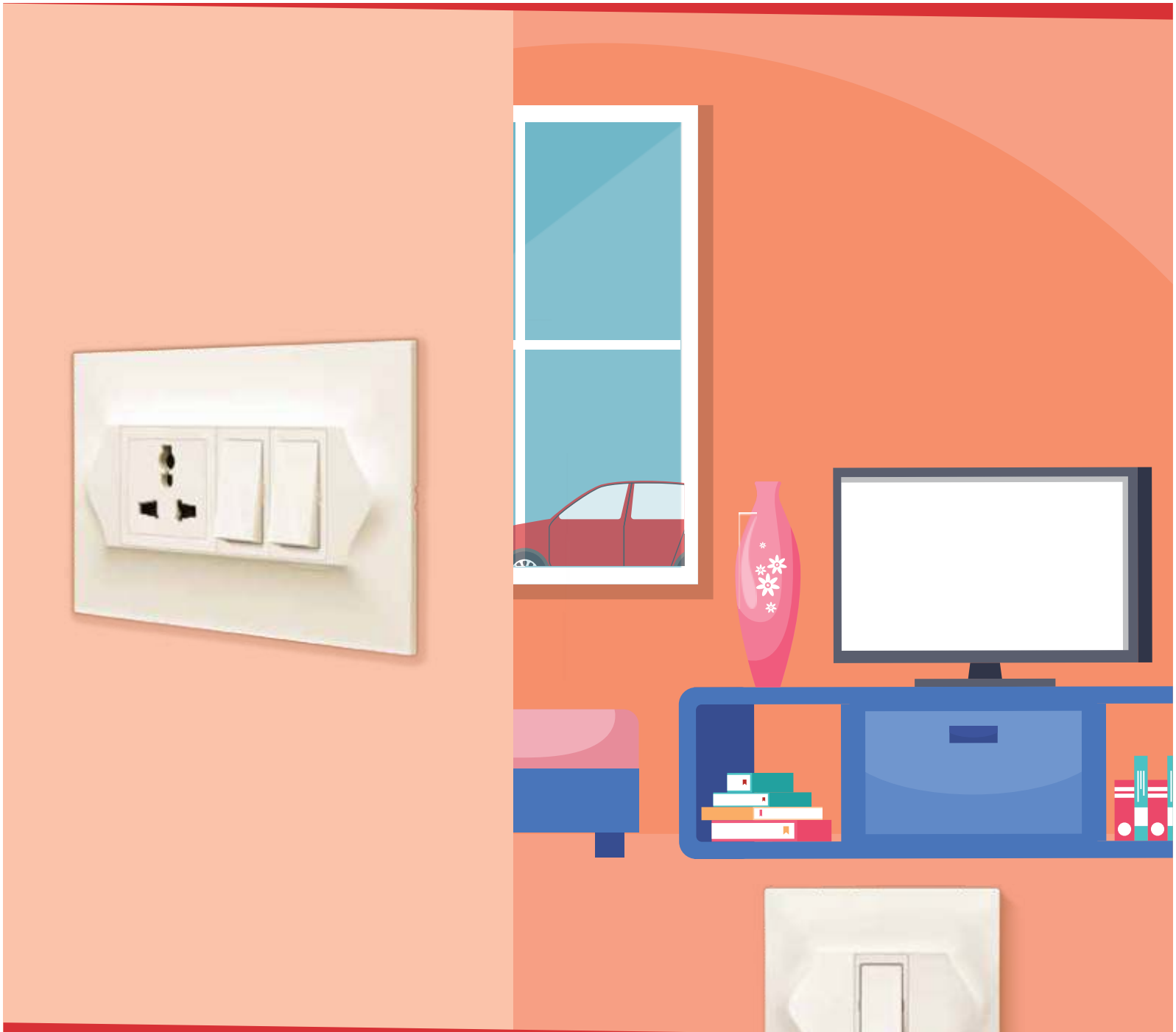

# GIVE YOUR WALLS AN EXPERIENCE OF GLINT DOUBLE PLATE



Suitable for Flush & Wooden boxes



Range from 1M to 18M



Comes with both wooden and metal screws



**Glint™ SWITCH / SWITCH WITH INDICATOR**

- Polycarbonate Material • LED Indicator • ISI Marked

HSN Code: 8536

	Description	Module	Pack	Cat. Nos.	Unit Price (₹)
	6A 1-way Switch	1	1/10/200	800000	26
	6A 2-way Switch	1	1/10/200	800001	58
	16A 1-way Switch	1	1/10/100	800002	78
	16A 2-way Switch	1	1/10/100	800003	96
	16A 1-way Switch with Indicator	1	1/10/100	800004	92
	20A DP Switch	2	1/10/50	800005	116
	32A DP Switch	2	1/10/50	800006	172
	6A Bell Push with Indicator-1M	1	1/10/100	800007	70
	6A Bell Push with Indicator-2M	2	1/10/100	800008	104

**Glint™ SOCKET / TELEPHONE SOCKET / COMPUTER SOCKET / TV SOCKET**

HSN Code: 8536

- Pencil Free Operation • Child Safety Shutter • Accommodate Wide Range of 2 Pin Round and Flat Pin Plugs

	Description	Module	Pack	Cat. Nos.	Unit Price (₹)
	6A 3 Pin Universal Socket	2	1/10/100	800020	60
	10A Euro US Socket	1	1/20/100	800021	52
	6/16A 3 Pin Socket	2	1/10/50	800022	114
	Multistandard Socket 6/10/13A-250V, 15A-127V	2	1/10/100	800023	108
	Telephone Socket - RJ11	1	1/20/100	800030	64
	Computer Socket- RJ45	1	1/20/100	800031	146
	TV Socket	1	1/20/100	800032	58

**Glint™ BUZZER / POWER UNIT / INDICATOR**

HSN Code: 8536

- Power Unit - Prewired, Suitable for 2 Ton Ac / 3.5 kw Geyser

	Description	Module	Pack	Cat. Nos.	Unit Price (₹)
	Buzzer - 230V	1	1/20/100	800040	156
	16A Power Unit for AC & Geyser	4	1/1/5	800025	270
	Flat Indicator Red	1	1/10/100	800033	76

**Glint™ FAN STEP REGULATOR**

HSN Code: 8414

- Fan Marking for Easy Identification

	Description	Module	Pack	Cat. Nos.	Unit Price (₹)
	Fan Step Regulator - 100W	1	1/10/100	800041	276
	Fan Step Regulator - 100W - 2M	2	1/10/100	800043	310

**Glint™ LIGHT DIMMER**

HSN Code: 8538

- Marking for Easy Identification

	Description	Module	Pack	Cat. Nos.	Unit Price (₹)
	Light Dimmer - 400W	1	1/10/100	800042	266

**Glint™ MINI MCB**

HSN Code: 8536

- Marking for Easy Identification

	Description	Module	Pack	Cat. Nos.	Unit Price (₹)
	MINI MCB SP 16A	1	1/10/100	800010	268
	MINI MCB SP 20A	1	1/10/100	800011	268
	MINI MCB SP 25A	1	1/10/100	800012	268
	MINI MCB SP 32A	1	1/10/100	800013	268

**Glint™ BLANK PLATE / SCREW CAPS**

HSN Code: 8538

- Spare Screw Caps Available

	Description	Module	Pack	Cat. Nos.	Unit Price (₹)
	1 Module Blank Plate	1	1/20/200	800051	22
	2 Module Blank Plate	2	1/10/100	800052	24
	Screw Caps	-	1/10/100	800059	18*

\* One Unit Contains Ten Pieces of Screw Caps

**Glint™ MODULAR PLATES - WHITE COLOUR**

- Unique Design - Sleek & Curvy
- Flame Retardant Material
- Compatible with all Standard Size Metal Flush & Plastic Surface Boxes

HSN Code: 8538

	Description	Module	Pack	Cat. Nos.	Unit Price (₹)
	1 Module Plate	1	1/10/100	800061	40
	2 Module Plate	2	1/10/100	800062	40
	3 Module Plate	3	1/10/100	800063	56
	4 Module Plate	4	1/10/100	800064	66
	6 Module Plate	6	1/5/50	800066	82
	8 Module Plate (Vertical)	8	1/5/25	800067	116
	8 Module Plate (Horizontal)	8	1/5/50	800068	108
	12 Module Plate	12	1/5/25	800065	148
	16 Module Plate	16	1/5/25	800069	156
	18 Module Plate	18	1/5/25	800070	188

**Glint™ MODULAR DOUBLE PLATES - WHITE COLOUR**

- Aesthetic Design
- Suitable for Metal Flush & Wooden Boxes
- Comes in both Metal & Wooden Screws

HSN Code: 8538

	Description	Module	Pack	Cat. Nos.	Unit Price (₹)
	Double Plate + Frame 1M	1	1/10/100	800071	72
	Double Plate + Frame 2M	2	1/10/100	800072	72
	Double Plate + Frame 3M	3	1/10/100	800073	92
	Double Plate + Frame 4M	4	1/10/100	800074	112
	Double Plate + Frame 6M	6	1/10/50	800076	142
	Double Plate + Frame 8M (Vertical)	8	1/5/25	800078	202
	Double Plate + Frame 8M (Horizontal)	8	1/10/50	800079	202
	Double Plate + Frame 10M	10	1/5/25	800080	236
	Double Plate + Frame 12M (Vertical)	12	1/5/25	800082	258
	Double Plate + Frame 12M (Horizontal)	12	1/5/25	800084	258
	Double Plate + Frame 16M	16	1/5/25	800086	292
	Double Plate + Frame 18M	18	1/5/25	800088	320

**Glint™ METAL FLUSH BOX**

• Made of G.I. Sheet • Earth Terminal for Safety

**HSN Code: 8538**

	Description	Module	Pack	Cat. Nos.	Unit Price (₹)
	Metal Flush Box - 1 / 2 Module	1 / 2	1/0/40	800172	50
	Metal Flush Box - 3 Module	3	1/0/40	800173	66
	Metal Flush Box - 4 Module	4	1/0/40	800174	78
	Metal Flush Box - 6 Module	6	1/0/20	800176	122
	Metal Flush Box - 8 Module(V)	8	1/0/20	800177	156
	Metal Flush Box - 8 Module(H)	8	1/0/20	800178	156
	Metal Flush Box - 12 Module	12	1/0/10	800175	206
	Metal Flush Box - 16 Module	16	1/0/10	800179	240
	Metal Flush Box - 18 Module	18	1/0/10	800180	254

**Glint™ SURFACE BOX**

• Flame Retardant Material • Edge to Edge Fitting with Glint Plate

**HSN Code: 8538**

	Description	Module	Pack	Cat. Nos.	Unit Price (₹)
	Plastic Surface Box 1/2 Module	1 / 2	1/0/50	800182	56
	Plastic Surface Box - 3 Module	3	1/0/35	800183	66
	Plastic Surface Box - 4 Module	4	1/0/25	800184	76
	Plastic Surface Box - 6 Module	6	1/0/10	800186	116
	Plastic Surface Box - 8 Module (V)	8	1/0/15	800187	162
	Plastic Surface Box - 8 Module (H)	8	1/0/10	800188	162
	Plastic Surface Box - 12 Module	12	1/0/10	800185	194
	Plastic Surface Box - 16 Module	16	1/0/10	800189	238
	Metal Surface Box - 18 Module	18	1/0/10	800190	258

**Cover Plates - Glint™**

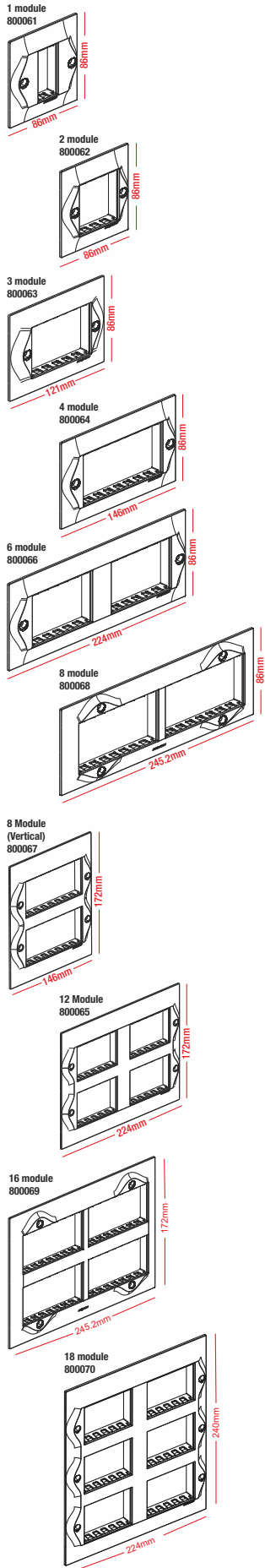

**Flush Boxes-Metal**

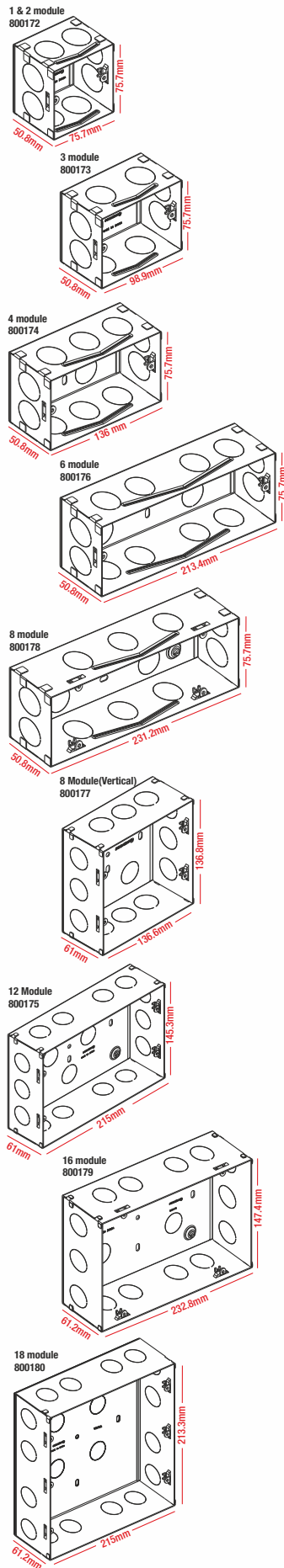

**Surface Boxes**

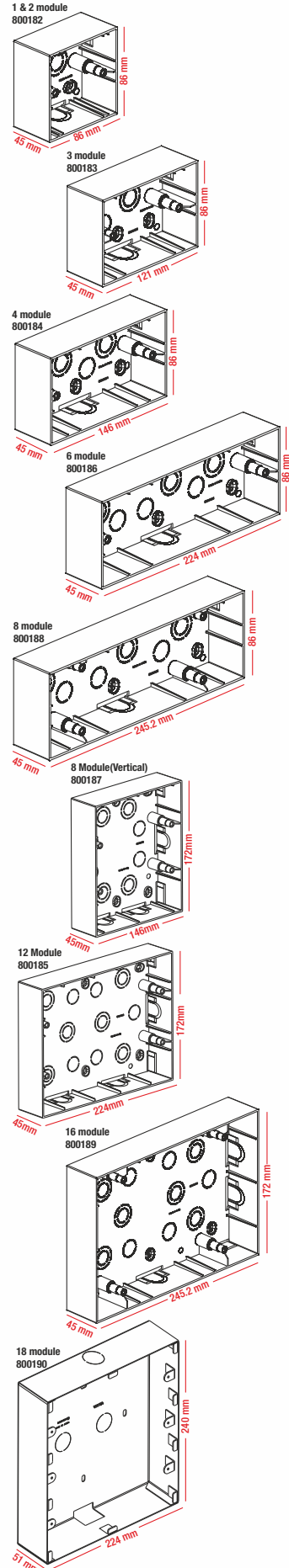

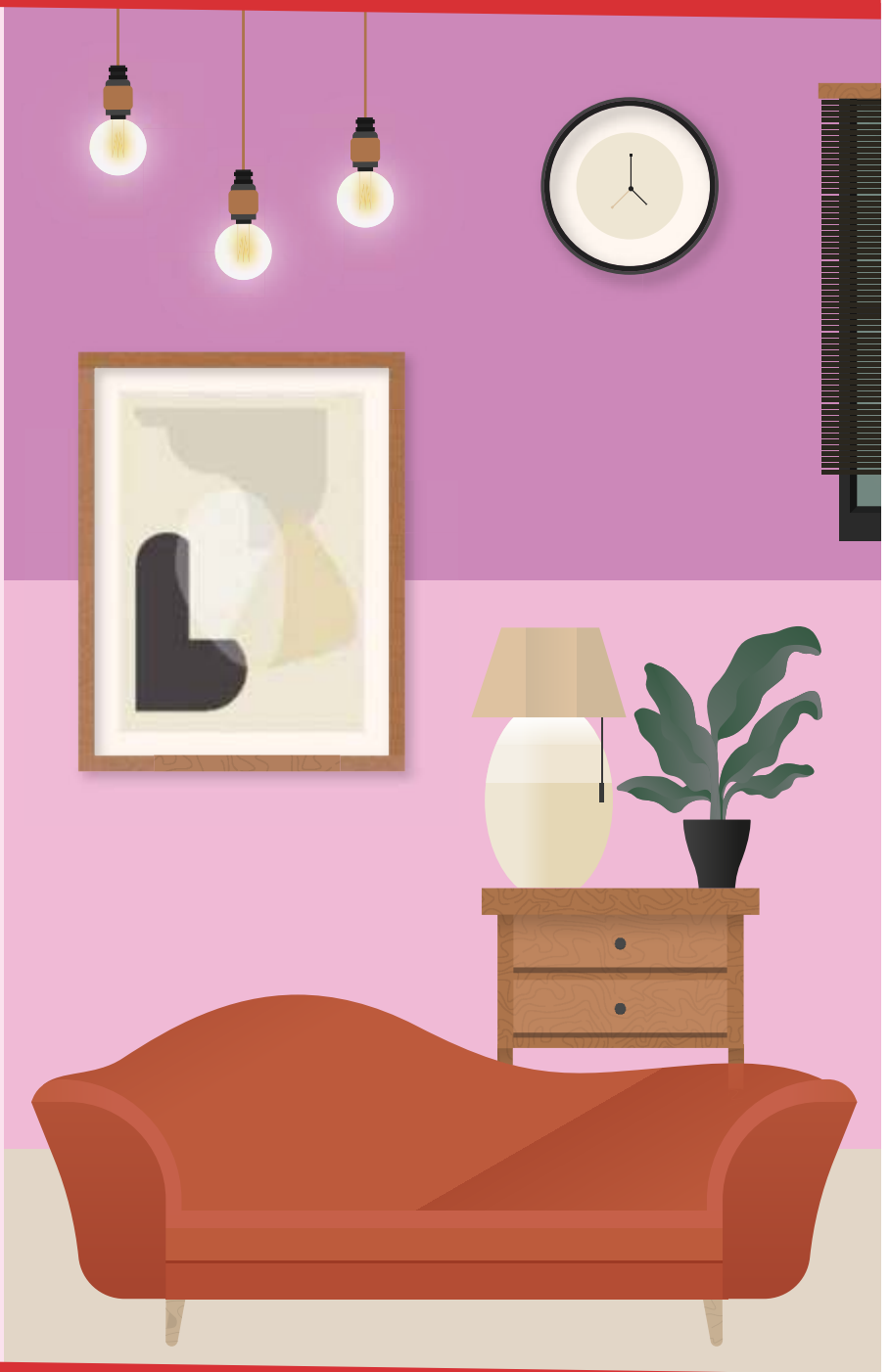

\*tested in a controlled environment

## SHINES EVEN BEFORE SWITCHING ON



Trending colors



Contemporary finishes



More resistant to scratches & fading\*

**#TurnOnYourStyleSense**

**ELVIRA**  
A SENSIBLE SWITCH

**ELVIRA SWITCH / SWITCH WITH INDICATOR**

A SENSIBLE SWITCH

• Polycarbonate Material • LED Based Indicator • Shrouded Terminal • ISI Marked

HSN Code: 8536

Description	Module	Pack	Cat. Nos.	Unit Price (₹)	
6A 1 way Switch	1	1/20/200	800100	32	
6A 2 way Switch	1	1/20/100	800101	76	
6A 1 way Switch with Indicator	1	1/20/200	800102	72	
16A 1 way Switch	1	1/20/200	800103	92	
16A 2 way Switch	1	1/10/100	800104	122	
16A 1way Switch with indicator	1	1/20/200	800105	114	
25A 1 way Switch with indicator	1	1/10/100	800106	160	
20A DP Switch	2	1/10/50	800107	156	
32A DP Switch	2	1/10/50	800108	212	
6A Bell Push with indicator - 1M	1	1/20/200	800110	78	
6A Bell Push with indicator - 2M	2	1/10/100	800111	122	

**ELVIRA SOCKET**

A SENSIBLE SWITCH

• Child Safety Shutter • Shrouded Terminals • Compatible with all standard Mobile chargers

HSN Code: 8536

Description	Module	Pack	Cat. Nos.	Unit Price (₹)	
6A 3 Pin Universal Socket	2	1/10/100	800120	82	
10A Euro US Socket	1	1/20/100	800121	70	
6/16A 3 Pin Socket	2	1/10/50	800122	144	
25A 3 Pin Socket	2	1/10/50	800124	166	
Multistandard Socket 6/10/13A-250v	2	1/10/100	800123	140	

**ELVIRA USB CHARGER**

A SENSIBLE SWITCH

Modular charging socket to charge your Mobile , Tested as per IS standard

HSN Code: 8536

Description	Module	Pack	Cat. Nos.	Unit Price (₹)	
USB Charger	1	10/100	800112	580	
USB Charger	2	5/50	800113	1112	

**ELVIRA RJ11 / RJ45 / TV SOCKET**

A SENSIBLE SWITCH

Tool less, Twisted operation Computer Socket/RJ45

HSN Code: 8536

Description	Module	Pack	Cat. Nos.	Unit Price (₹)	
Telephone Socket - RJ11	1	1/20/100	800130	78	
Computer Socket - RJ45 Cat 6	1	1/20/100	800131	208	
TV Socket	1	1/20/100	800132	76	

**ELVIRA FAN REGULATOR**

A SENSIBLE SWITCH

• Laser marking

HSN Code: 8414

Description	Module	Pack	Cat. Nos.	Unit Price (₹)	
Fan Step Regulator 100W - 1M	1	1/10/100	800141	304	
Fan Step Regulator 100W - 2M	2	1/10/100	800142	370	

**ELVIRA POWER UNIT / CONTROL PRODUCTS / MINI MCB**

A SENSIBLE SWITCH

- LED Indicator • Pre-Wired Power Unit

HSN Code: 8536

	Description	Module	Pack	Cat. Nos.	Unit Price (₹)
	Buzzer 230V	1	1/20/100	800140	218
	Power Unit with 16A AC & GYSR	3	1/1/5	800125	304
	Power Unit with 20A MCB & PLUG	3	1/1/5	800193	742
	Power Unit with 25A MCB & PLUG	3	1/1/5	800194	800
	Bell Call Indicator	1	1/20/100	800144	474
	Flat Indicator Red	1	1/20/100	800154	92
	Skirting light - 2M	2	1/5/25	800155	340
	25A Motor Starter	2	1/5/25	800196	360
	16A Mini MCB SP C curve	1	1/10/100	800160	320
	20A Mini MCB SP C curve	1	1/10/100	800191	320
	25A Mini MCB SP C curve	1	1/10/100	800156	320
	32A Mini MCB SP C curve	1	1/10/100	800157	320

**ELVIRA LIGHT DIMMER**

A SENSIBLE SWITCH

- Laser marking

HSN Code: 8538

	Description	Module	Pack	Cat. Nos.	Unit Price (₹)
	Light Dimmer 400W	1	1/10/100	800143	312

**ELVIRA HOTEL FUNCTION (KEY CARD AND DND)**

A SENSIBLE SWITCH

- LED Indicator

HSN Code: 8538

	Description	Module	Pack	Cat. Nos.	Unit Price (₹)
	DND Internal Unit	1	1/10/100	800192	168
	DND External Unit	1	1/10/100	800195	198
	Ket Card SW 16A	2	1/10/50	800197	1948

**ELVIRA BLANK PLATES / CABLE OUTLET**

A SENSIBLE SWITCH

- Polycarbonate Material

HSN Code: 8538

	Description	Module	Pack	Cat. Nos.	Unit Price (₹)
	1 module Blank	1	1/20/200	800151	26
	2 module Blank	2	1/10/100	800152	42
	Cable outlet	1	1/20/100	800153	66

**ELVIRA MODULAR PLATE WITH SUPPORT FRAME - WHITE**

A SENSIBLE SWITCH

- Strong Dimensional Stability

HSN Code: 8538

	Description	Module	Pack	Cat. Nos.	Unit Price (₹)
	1 Module Plate	1	1/10/100	800161	60
	2 Module Plate	2	1/10/100	800162	60
	3 Module Plate	3	1/10/100	800163	82
	4 Module Plate	4	1/10/100	800164	88
	6 Module Plate	6	1/5/50	800166	118
	8 Module Plate (Horizontal)	8	1/5/50	800168	156
	8 Module Plate (Vertical)	8	1/5/25	800167	160
	12 Module Plate	12	1/5/25	800165	230
	16 Module Plate	16	1/5/25	800169	262
	18 Module Plate	18	1/5/25	800170	312

**ELVIRA MODULAR PLATE WITH SUPPORT FRAME - SILVER LIGHT PURPLE**

A SENSIBLE SWITCH

• Strong Dimensional Stability



HSN Code: 8538

 	Description	Module	Pack	Cat. Nos.	Unit Price (₹)
	Silver Light purple Plate 1M	1	1/10/100	800201	110
	Silver Light purple Plate 2M	2	1/10/100	800202	110
	Silver Light purple Plate 3M	3	1/10/100	800203	136
	Silver Light purple Plate 4M	4	1/10/100	800204	156
	Silver Light purple Plate 6M	6	1/5/50	800205	230
	Silver Light purple Plate 8M (Horizontal)	8	1/5/50	800206	244
	Silver Light purple Plate 8M (Vertical)	8	1/5/25	800207	294
	Silver Light purple Plate 12M	12	1/5/25	800208	420
	Silver Light purple Plate 16M	16	1/5/25	800209	574
Silver Light purple Plate 18M	18	1/5/25	800210	598	

**ELVIRA MODULAR PLATE WITH SUPPORT FRAME - INOX SILVER**

A SENSIBLE SWITCH



HSN Code: 8538

 	Description	Module	Pack	Cat. Nos.	Unit Price (₹)
	Inox Silver Plate 1M	1	1/10/100	800211	110
	Inox Silver Plate 2M	2	1/10/100	800212	110
	Inox Silver Plate 3M	3	1/10/100	800213	136
	Inox Silver Plate 4M	4	1/10/100	800214	156
	Inox Silver Plate 6M	6	1/5/50	800215	230
	Inox Silver Plate 8M (Horizontal)	8	1/5/50	800216	244
	Inox Silver Plate 8M (Vertical)	8	1/5/25	800217	294
	Inox Silver Plate 12M	12	1/5/25	800218	420
	Inox Silver Plate 16M	16	1/5/25	800219	574
Inox Silver Plate 18M	18	1/5/25	800220	598	

**ELVIRA MODULAR PLATE WITH SUPPORT FRAME - POLARISED GREY**

A SENSIBLE SWITCH



HSN Code: 8538

 	Description	Module	Pack	Cat. Nos.	Unit Price (₹)
	Polarised Grey Plate 1M	1	1/10/100	800221	110
	Polarised Grey Plate 2M	2	1/10/100	800222	110
	Polarised Grey Plate 3M	3	1/10/100	800223	136
	Polarised Grey Plate 4M	4	1/10/100	800224	156
	Polarised Grey Plate 6M	6	1/5/50	800225	230
	Polarised Grey Plate 8M (Horizontal)	8	1/5/50	800226	244
	Polarised Grey Plate 8M (Vertical)	8	1/5/25	800227	296
	Polarised Grey Plate 12M	12	1/5/25	800228	420
	Polarised Grey Plate 16M	16	1/5/25	800229	574
Polarised Grey Plate 18M	18	1/5/25	800230	598	

**ELVIRA MODULAR PLATE WITH SUPPORT FRAME - ASH PURPLE**

A SENSIBLE SWITCH

HSN Code: 8538

 	Description	Module	Pack	Cat. Nos.	Unit Price (₹)
	Ash Purple Plate 1M	1	1/10/100	800231	110
	Ash Purple Plate 2M	2	1/10/100	800232	110
	Ash Purple Plate 3M	3	1/10/100	800233	136
	Ash Purple Plate 4M	4	1/10/100	800234	156
	Ash Purple Plate 6M	6	1/5/50	800235	230
	Ash Purple Plate 8M (Horizontal)	8	1/5/50	800236	244
	Ash Purple Plate 8M (Vertical)	8	1/5/25	800237	296
	Ash Purple Plate 12M	12	1/5/25	800238	420
	Ash Purple Plate 16M	16	1/5/25	800239	574
Ash Purple Plate 18M	18	1/5/25	800240	598	



**ELVIRA METAL FLUSH BOX**

A SENSIBLE SWITCH

• Made of G.I. Sheet • Earth Terminal for Safety

HSN Code: 8538

	Description	Module	Pack	Cat. Nos.	Unit Price (₹)
	Metal Flush Box - 1 / 2 Module	1 / 2	1/0/40	800172	50
	Metal Flush Box - 3 Module	3	1/0/40	800173	66
	Metal Flush Box - 4 Module	4	1/0/40	800174	78
	Metal Flush Box - 6 Module	6	1/0/20	800176	122
	Metal Flush Box - 8 Module(V)	8	1/0/20	800177	156
	Metal Flush Box - 8 Module(H)	8	1/0/20	800178	156
	Metal Flush Box - 12 Module	12	1/0/10	800175	206
	Metal Flush Box - 16 Module	16	1/0/10	800179	240
	Metal Flush Box - 18 Module	18	1/0/10	800180	254

**ELVIRA SURFACE BOX**

A SENSIBLE SWITCH

• Flame Retardant Material • Edge to Edge Fitting with Plate

HSN Code: 8538

	Description	Module	Pack	Cat. Nos.	Unit Price (₹)
	Plastic Surface Box 1/2 Module	1 / 2	1/0/50	800182	56
	Plastic Surface Box - 3 Module	3	1/0/35	800183	66
	Plastic Surface Box - 4 Module	4	1/0/25	800184	76
	Plastic Surface Box - 6 Module	6	1/0/10	800186	116
	Plastic Surface Box - 8 Module (V)	8	1/0/15	800187	162
	Plastic Surface Box - 8 Module (H)	8	1/0/10	800188	162
	Plastic Surface Box - 12 Module	12	1/0/10	800185	194
	Plastic Surface Box - 16 Module	16	1/0/10	800189	238
	Metal Surface Box - 18 Module	18	1/0/10	800190	258

**3 PIN PLUGS WITH EASY GRIP**

• White Matte Finish • Tested as per IS 1293

HSN Code: 8536

	Description	Module	Pack	Cat. Nos.	Unit Price (₹)
	6A 3 Pin Plug	1	1/10/50	698470	68
	16A 3 Pin Plug	2	1/10/50	698471	92

**Cover Plates - ELVIRA**  
A SENSIBLE SWITCH

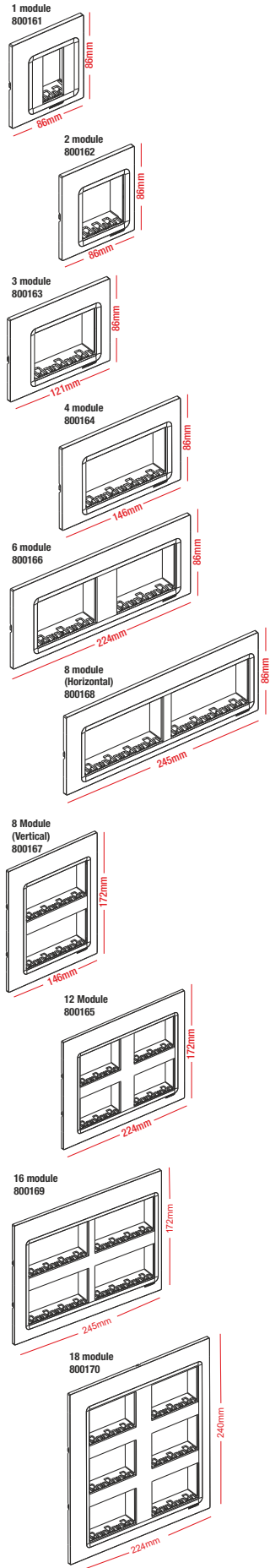

**Flush Boxes-Metal**

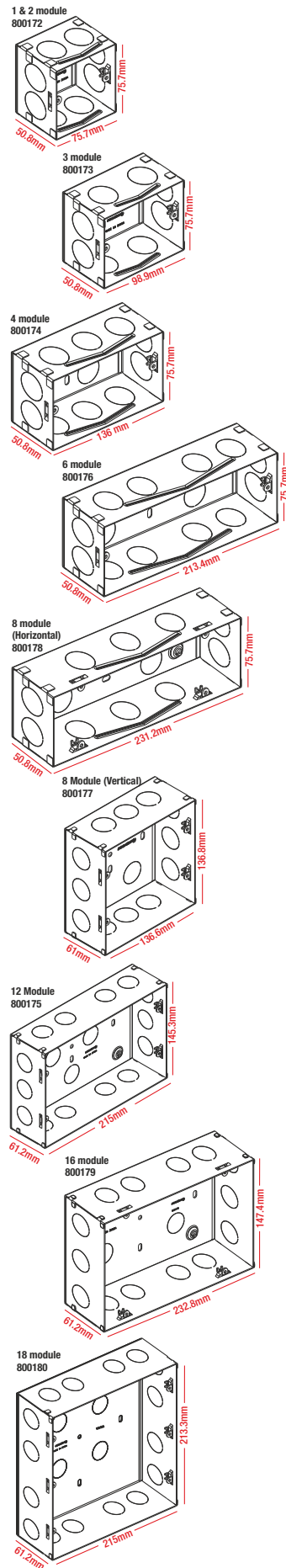

**Surface Boxes**

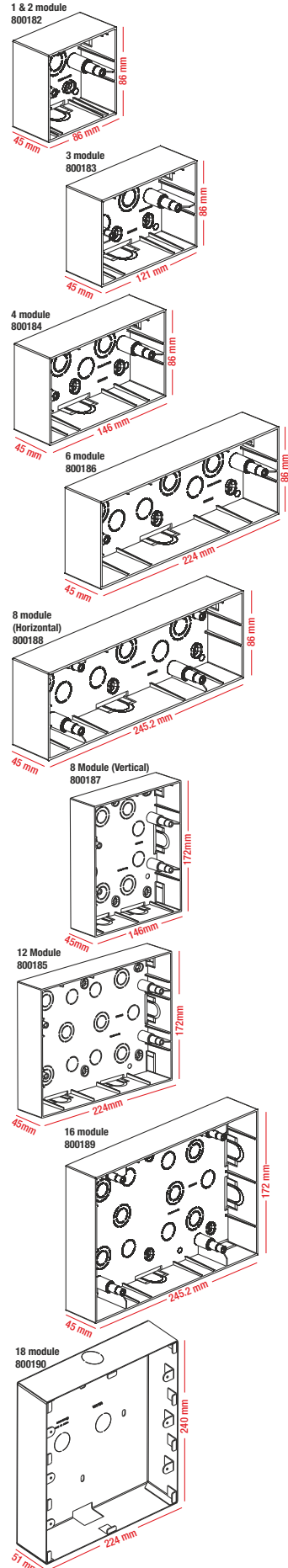

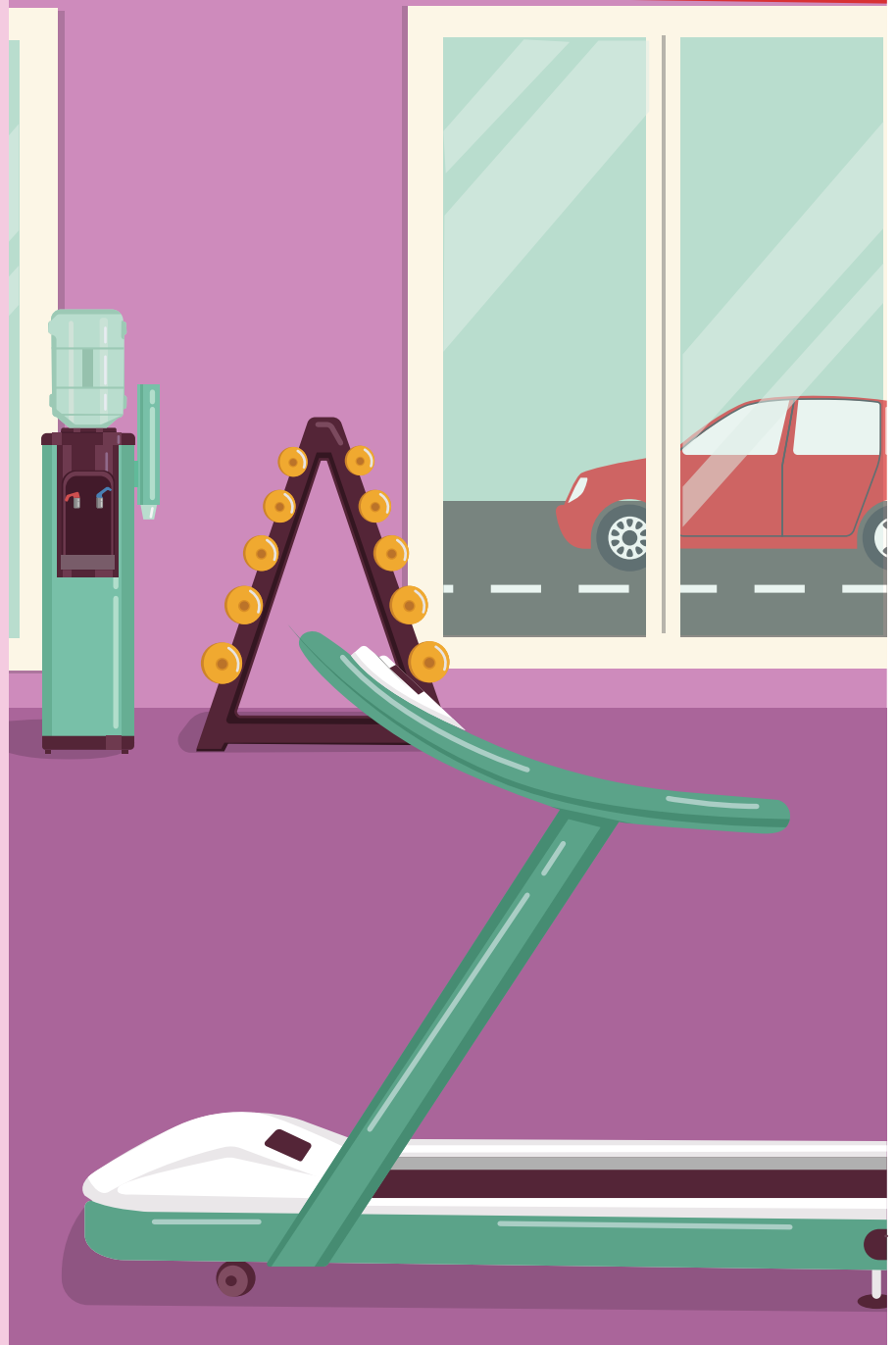
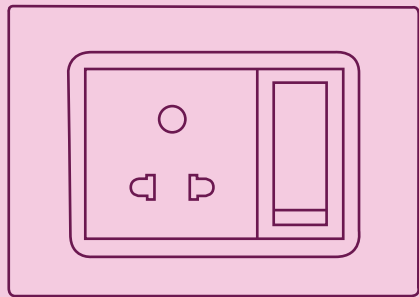

## UNIQUE AESTHETIC DESIGN - PLUGS WITH EASY GRIP



White Matte  
 Finish



Tested as  
 per IS 1293

Description	HSN Code	Pack	Cat. Nos.	Unit Price (₹)
6A 3 PIN PLUG	8536	1/10/50	698470	68
16A 3 PIN PLUG	8536	1/10/50	698471	92

**PLUG**

## GENERAL TERMS

- This price list supersedes all previous price lists.
- All prices are in Indian Rupees only.
- All prices are Maximum Retail Prices (MRP) inclusive of GST as applicable.
- Our discount structure is exclusive of GST
- Orders will be accepted in multiples of standard packing.
- Prices are subject to change without notice. All despatches will be as per prices prevailing on the date of despatch. Prices are ex-godown, exclusive of packing/forwarding/freight and insurance.
- Product design is subject to change without notice for continuous up gradation.
- Disputes if any are subject to Delhi Jurisdiction only.
- Company reserves the right to issue amendments which may arise due to any printing errors in the price list.

## WARRANTY

IA products carry a warranty against manufacturing defects, subject to use of the product for the right application, with correct wiring/connection and normal operating conditions. Please refer to detailed IndoAsian warranty policy effective 1<sup>st</sup> Jan 2016.

MCBs	36 Months
RCCBs	36 Months
DBs/ACCL	12 Months
Rewirable/HRC Fuses	6 Months
MCCBs/BFF/Fuse Bases/Changeover Switchgears/SDF	12 Months
Time Switches	12 Months
For Wiring Devices - Switches & Socket	120 Months
For Wiring Devices - Electronic Products (e.g. Fan Regulator, Dimmer, Buzzer, RJ45, RJ11 & TV Sockets, Bell Indicator, Motor starter, Skirting light)	24 Months

## CHANNEL PARTNER

**CORPORATE OFFICE:** V. J. Business Towers, A-6, 1st Floor, Sector-125, Noida-201301, U.P., India. Ph.: +91-0120-3305111 E-mail: customer.care@indoasian.com, international@indoasian.com Website: www.indoasian.com

**CUSTOMER CARE HEAD:** Novateur Electrical & Digital Systems Pvt. Ltd., V. J. Business Towers, A-6, 1st Floor, Sector-125, Noida-201301, U.P., India. Ph.: +91-0120-3305100 E-mail: customer.care@indoasian.com

### NORTH

**Regional Sales office  
DELHI NCR**  
V. J. Business Towers  
A-6, Ground Floor,  
Sector-125, Noida-201303  
Ph.: 0120-6858900

**Branch office  
CHANDIGARH**  
S.C.O.-11, 2nd Floor,  
Sector-26, Madhya Marg,  
Chandigarh-160002  
Ph.: 0172-3934651

**Branch office  
JAIPUR**  
433, 4th Floor, Ganpati Plaza,  
M. I. Road,  
Jaipur-302001  
Ph.: 0141-4113528

**Branch office  
LUCKNOW**  
301, 3rd Floor, Chintel House,  
Station Road,  
Lucknow-226001  
Ph.: 0522-4013210

### SOUTH

**Regional Sales office  
BANGALORE**  
787, 1st Floor "Skyline Vista"  
15th Cross, 100 Feet Ring Road  
J P Nagar 1st Phase  
Bangalore-560 078  
Tel: 080-46219989

**Branch office  
COCHIN**  
Door No.65/1317, Syda Building,  
2nd Floor, Kaloor-Kadavanthra Road,  
Kaloor, Ernakulam District,  
Kochi-682017 (Kerala)  
Ph.: 0484-405581-88

**Branch office  
COIMBATORE**  
Door No. 83,  
Dr. Nanjappa Road,  
Coimbatore-641018  
Ph.: 0422-2302715

**Branch office  
CHENNAI**  
No.5, 1st Floor, Mahalingapuram Main Road,  
Nungambakkam,  
Chennai-600034  
Ph.: 044-28172096, 28170527

**Branch office  
HYDERABAD**  
312, 3rd Floor,  
Amrutha Estates, Himayath Nagar,  
Hyderabad-500029  
Ph.: 040-66742425

### WEST

**Regional Sales office  
MUMBAI**  
401 & 408, K.P. Arrum,  
Marol Morshi Road, Andheri East,  
Mumbai-400059  
Ph.: 022-61035800

**Branch office  
AHMEDABAD**  
102, 1st Floor, Shivalik High Street,  
Near Mansi Circle, Vastrapur,  
Ahmedabad-380015  
Ph.: 079-29701351-53

**Branch office  
INDORE**  
202, KK Bafna Arcade,  
Janjeerwala Square,  
Race Course Road,  
Indore-452001  
Ph.: 0731-4064064

**Branch office  
PUNE**  
311, Pride Silicon Plaza,  
Bhamburda, Shivaji Nagar,  
Senapati Bapat Marg,  
Pune-411016  
Ph.: 8087610722

### EAST

**Regional Sales office  
KOLKATA**  
"Raikva Building" Room No. 8, 2nd Floor,  
3A Ram Mohan Garden Lane,  
Beliaghata E.M.Bypass, Kolkata-700010  
Ph.: 033-66041503

IA/Retail Price List/11-2010000

**INDOASIAN**  
MAKES SENSE

**WESUPPORT**

E-mail: customer.care@indoasian.com

**INDOASIAN**  
MAKES SENSE