

WE THINK
YOU LIVE
BETTER BETTER

ELVIRA

A SENSIBLE SWITCH

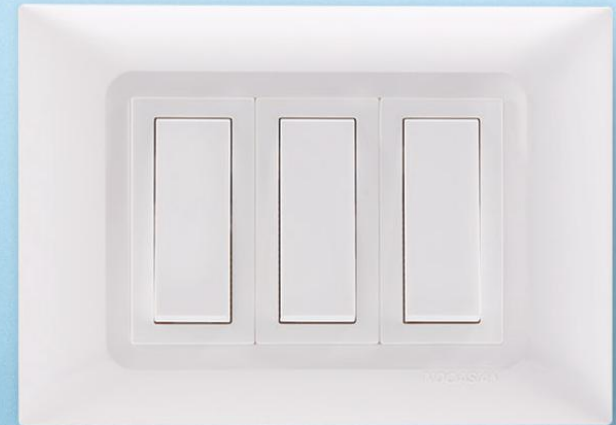

DISCOVER
THE THINKING
THAT GOES INTO
MAKING LIFE
BETTER.

Before we started creating a top quality switch, we put you at the centre of our thinking. And while this seemed easy, the thought that



went into creating a superior-quality, longer lasting, greater value-for-money product wasn't an easy task. We focused on attributing it with better features and better functionality, but more importantly, making it more practical. And when it all came together, it just made the best sense.

Elvira: A Sensible Switch.

Because at IndoAsian, *everything* **Makes Sense.**

FEATURES

There are so many reasons why Elvira is the right choice for you. We've listed 12 sound and sensible ways in which Elvira can help you live better. We're sure you will be able to find 12 more.



DESIGNED FOR YOU

Neutral, white colour

Everyone prefers pure and bright white, not because it's simply a better choice but because it's more elegant. It gives you more options and the flexibility to change wall colours.

Built to last

Elvira is also designed to last longer. From curved, screw-free exteriors, to honeycomb base plates, there are even flexible clips for greater stability and strength.



COMPLETELY
COMPATIBLE



Simple 3 pin design

Loose connections are now a thing of the past. The simplified three-pin design has flat and round terminals which means compatibility with all 2 and 3 pin plugs.



SERIOUSLY SAFE

Shrouded terminals

This minimises exposure from accidental contact with live screws and terminals during installation for the electrician.

Base shutters

We've moved the shutter from the top round hole to the base, thereby needing contact from both plug pins and giving complete protection to the curious child.



TOTALLY TRUSTWORTHY



Quality standards

There's a reason why IndoAsian is preferred; the ISI mark is a universally-recognised quality standard. Rigorous testing exceeding 1 lakh On/Off operations means that our switches will last you more than a decade.

HIGHLY DURABLE



High-grade Polycarbonate switches

Our Polycarbonate switches are FR grade with sun protection. They are heat-resistant, flame-retardant and even UV-stabilised. The high grade of Polycarbonate that we use adds to the structural stability.

EXTRA
EFFICIENT



Detailing for installation

Behind every switch we've indicated which side is Top, which means your electrician will always install the products correctly. No mixing up of directions, no time wasted.

EFFECTIVELY POWERED



Unique indicator switches

Our indicator switches are powered with LED, which implies longer life and less energy consumption.

The unique indicator design delivers brightness greater than neon indicators, making it even more efficient.

TRULY PERMANENT

Laser-etched switches

Laser technology replaces printing and painting for easy identification of product ratings and descriptions. All our switches are permanently etched in high-contrast, clear figures and letters that are guaranteed to last long.



The Elvira wiring system consists of switches, sockets and indicators that are functional, yet packed with features. This high-quality range extends to more products that simply improve your life. This includes separate dimmers and fan regulators that aren't interchangeable, call bells and push bells with indicators, skirting lights, and 25A sockets and motor starters.



6A/16A 1way Switch



6A/16A 2way Switch



6A/16A/25A 1way Switch with indicator



6A 3 Pin Universal Socket



10A Euro US Socket



Multistandard Socket 6/10/13A-250v

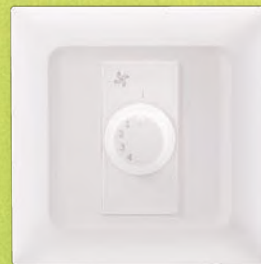

Fan Step Regulator 100W -1M



Fan Step Regulator 100W - 2M



Light Dimmer 400W

BRING HOME
THE INDOASIAN
USB CHARGER
WITH THE
ELVIRA FAMILY.



Fast
Charging



Compact



Aesthetically
Pleasing Designs

Product Name	Cat. No.	MRP (₹)	Packing
USB 1 Module	800112	580	10/100
USB 2 Module	800113	998	5/50

RELIABLE PROTECTION
FOR EXPENSIVE APPLIANCES.

Pre-wired Power Unit with MCB and Plug



Winning Features



Overload and
shortcircuit
protection



Suitable for
one-point protection
for your home
appliances



Pre-fitted
in Plastic
Surface Box



Compact and
aesthetically
good in terms
of design

IS

Plug and MCB
tested as per
IS standards



Well-designed
plug with top hand
gripping for better
fitment and removal

Product Name	Cat. No.	MRP (₹)	Packing
3M 20A MCB with Plug	800193	688	1/10
3M 25A MCB with Plug	800194	738	1/10

ELVIRA
A SENSIBLE SWITCH



20A/32A DP Switch



6A Bell Push with indicator - 1M



6A Bell Push with indicator - 2M

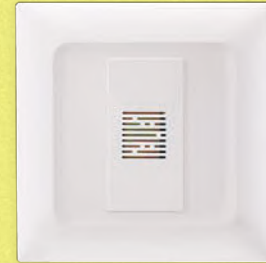

Buzzer 230V

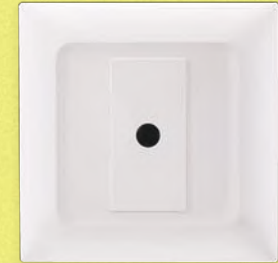

Cable Outlet



6/16A 3 Pin Socket

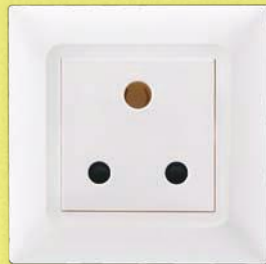

25A 3 Pin Socket



TV Socket



Tel Socket - RJ11



Computer Socket
RJ45 Cat 6



Bell Call Indicator

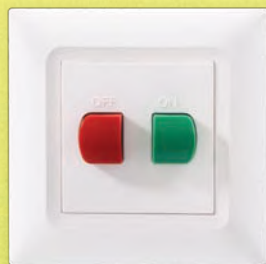

25A Motor Starter



Flat Indicator Red



Skirting Light - 2M

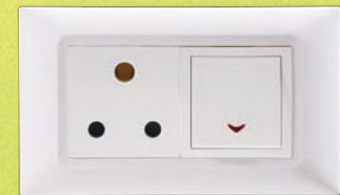

16A Power Unit for
AC/ Geyser

INSTALLATION PROCESS

Installing a sensible switch is a simple process.
Here's how:



Fix the metal box either
into or on the wall.



Press-fit the switch and
socket into the base frame.

Connect the wires
to the switch and socket.



Fix the connected and wired base frame to the metal box.





For a smooth and seamless look, press-fit the cover plate to the base frame.

ELVIRA

A SENSIBLE SWITCH

Switches

	Cat. Nos.	Description	Module	Pack
	800100	6A 1 way Switch	1	1/20/200

	Cat. Nos.	Description	Module	Pack
	800101	6A 2 way Switch	1	1/20/100

	Cat. Nos.	Description	Module	Pack
	800102	6A 1 way Switch with Indicator	1	1/20/200

	Cat. Nos.	Description	Module	Pack
	800103	16A 1 way Switch	1	1/20/200

	Cat. Nos.	Description	Module	Pack
	800104	16A 2 way Switch	1	1/10/100

	Cat. Nos.	Description	Module	Pack
	800105	16A 1 way Switch with Indicator	1	1/20/200

	Cat. Nos.	Description	Module	Pack
	800106	25A 1 way Switch with Indicator	1	1/10/100

	Cat. Nos.	Description	Module	Pack
	800107	20A DP Switch	2	1/10/50

	Cat. Nos.	Description	Module	Pack
	800108	32A DP Switch	2	1/10/50

	Cat. Nos.	Description	Module	Pack
	800110	6A Bell Push with Indicator-1M	1	1/20/200

	Cat. Nos.	Description	Module	Pack
	800124	25A 3 Pin Socket	2	1/10/50

	Cat. Nos.	Description	Module	Pack
	800111	6A Bell Push with Indicator-2M	2	1/10/100

	Cat. Nos.	Description	Module	Pack
	800123	Multistandard Socket 6/10/13A-250v	2	1/10/100

Sockets

Rj11 / Rj45 / TV Socket

	Cat. Nos.	Description	Module	Pack
	800120	6A 3 Pin Universal Socket	2	1/10/100

	Cat. Nos.	Description	Module	Pack
	800130	Telephone Socket -RJ11	1	1/20/100

	Cat. Nos.	Description	Module	Pack
	800121	10A Euro US Socket	1	1/20/100

	Cat. Nos.	Description	Module	Pack
	800131	Computer Socket -RJ45 Cat 6	1	1/20/100

	Cat. Nos.	Description	Module	Pack
	800122	6/16A 3 Pin Socket	2	1/10/50

	Cat. Nos.	Description	Module	Pack
	800132	TV Socket	1	1/20/100

Electronic Products

	Cat. Nos.	Description	Module	Pack
	800140	Buzzer 230V	1	1/20/100

	Cat. Nos.	Description	Module	Pack
	800141	Fan Step Regulator 100W-1M	1	1/10/100

	Cat. Nos.	Description	Module	Pack
	800142	Fan Step Regulator 100W-2M	2	1/10/100

	Cat. Nos.	Description	Module	Pack
	800154	Flat Indicator Red	1	1/20/100

Power Unit - Pre wired

	Cat. Nos.	Description	Module	Pack
	800125	16A Power unit for AC & Geyser	4	1/1/5

Light Dimmer

	Cat. Nos.	Description	Module	Pack
	800143	Light Dimmer 400W	1	1/10/100

Bell Call Indicator

	Cat. Nos.	Description	Module	Pack
	800144	Bell Call Indicator	1	1/20/100

Motor Starter

	Cat. Nos.	Description	Module	Pack
	800196	25A Motor Starter	2	1/10/50

Mini MCB

	Cat. Nos.	Description	Module	Pack
	800160	16A Mini MCB SP C curve	1	1/10/100

	Cat. Nos.	Description	Module	Pack
	800191	12A Mini MCB SP C curve	1	1/10/100

	Cat. Nos.	Description	Module	Pack
	800152	2 Module Blank	2	1/10/100

	Cat. Nos.	Description	Module	Pack
	800153	Cable outlet	1	1/20/100

Skirting Light

	Cat. Nos.	Description	Module	Pack
	800155	Skirting light -2M	2	1/5/25

Modular Plate with support frame - White

	Cat. Nos.	Description	Module	Pack
	800161	1 Module Plate	1	1/10/100

Blank Plate / Cable Outlet

	Cat. Nos.	Description	Module	Pack
	800151	1 Module Blank	1	1/20/200

	Cat. Nos.	Description	Module	Pack
	800162	2 Module Plate	2	1/10/100

Modular Plate with support frame - White

	Cat. Nos.	Description	Module	Pack
	800163	3 Module Plate	3	1/10/100

	Cat. Nos.	Description	Module	Pack
	800164	4 Module Plate	4	1/10/100

	Cat. Nos.	Description	Module	Pack
	800166	6 Module Plate	6	1/5/50

	Cat. Nos.	Description	Module	Pack
	800167	8 Module Plate (Vertical)	8	1/5/25

	Cat. Nos.	Description	Module	Pack
	800168	8 Module Plate (Horizontal)	8	1/5/50

	Cat. Nos.	Description	Module	Pack
	800165	12 Module Plate	12	1/5/25

	Cat. Nos.	Description	Module	Pack
	800169	16 Module Plate	16	1/5/25

	Cat. Nos.	Description	Module	Pack
	800170	18 Module Plate	18	1/5/25

Metal Flush Box

	Cat. Nos.	Description	Module	Pack
	800172	Metal Flush Box -1/2 Module	1/2	1/0/40

	Cat. Nos.	Description	Module	Pack
	800173	Metal Flush Box -3 Module	3	1/0/40

	Cat. Nos.	Description	Module	Pack
	800174	Metal Flush Box -4 Module	4	1/0/40

	Cat. Nos.	Description	Module	Pack
	800176	Metal Flush Box -6 Module	6	1/0/40

	Cat. Nos.	Description	Module	Pack
	800177	Metal Flush Box -8 Module(V)	8	1/0/20

	Cat. Nos.	Description	Module	Pack
	800178	Metal Flush Box -8 Module(H)	8	1/0/40

	Cat. Nos.	Description	Module	Pack
	800175	Metal Flush Box -12 Module	12	1/0/10

	Cat. Nos.	Description	Module	Pack
	800179	Metal Flush Box -16 Module	16	1/0/10

	Cat. Nos.	Description	Module	Pack
	800180	Metal Flush Box -18 Module	18	1/0/10

Surface Box

	Cat. Nos.	Description	Module	Pack
	800182	Plastic Surface Box 1/2 Module	1/2	1/0/50

Surface Box

	Cat. Nos.	Description	Module	Pack
	800183	Plastic Surface Box -3 Module	3	1/0/35

	Cat. Nos.	Description	Module	Pack
	800184	Plastic Surface Box -4 Module	4	1/0/25

	Cat. Nos.	Description	Module	Pack
	800186	Plastic Surface Box -6 Module	6	1/0/10

	Cat. Nos.	Description	Module	Pack
	800187	Plastic Surface Box -8 Module(V)	8	1/0/15

	Cat. Nos.	Description	Module	Pack
	800188	Plastic Surface Box -8 Module(H)	8	1/0/10

	Cat. Nos.	Description	Module	Pack
	800185	Plastic Surface Box -12 Module	12	1/0/10

	Cat. Nos.	Description	Module	Pack
	800189	Plastic Surface Box -16 Module	16	1/0/10

	Cat. Nos.	Description	Module	Pack
	800190	Metal Surface Box -18 Module	18	1/0/10

WARRANTY

Elvira products ensure a warranty against manufacturing defects, subject to use of the product for the right application, with correct wiring/ connection and normal operating conditions. Please refer to detailed IndoAsian warranty policy effective 1st January 2016.

For all Switches & Sockets: 10 Years

For all Electronic Products: 2 Years

(e.g. Fan Regulator, Dimmer, Buzzer, RJ45, RJ11, TV Sockets, Bell Call Indicator, Motor Starter, Skirting Light & Indicator)

Cover Plates

1 module
800161

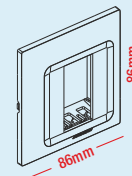

2 module
800162

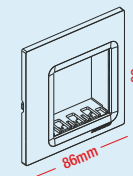

3 module
800163

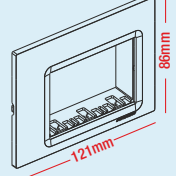

Flush Boxes-Metal

1 & 2 module
800172

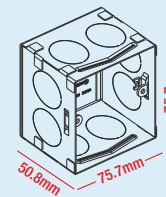

3 module
800173

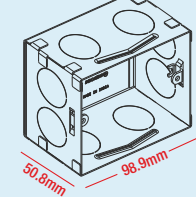

4 module
800174

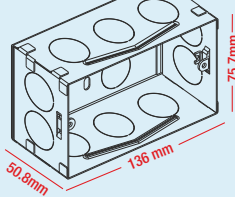

Surface Boxes

1 & 2 module
800182

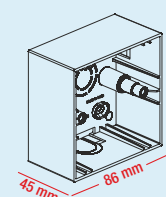

3 module
800183

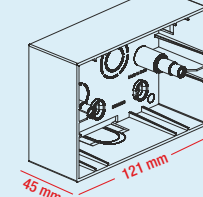

4 module
800184

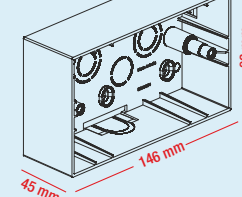

4 module
800164

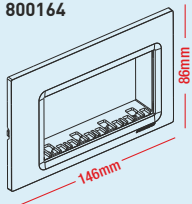

6 module
800166

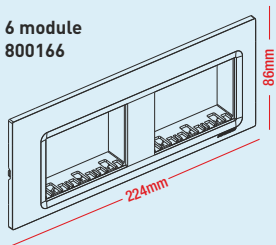

8 module (Horizontal)
800168

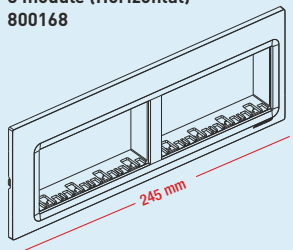

8 module (Vertical)
800167

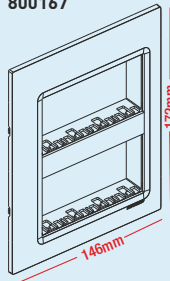

12 module
800165

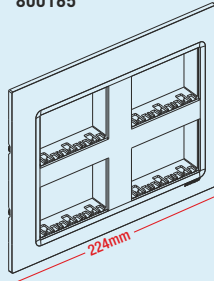

16 module
800169

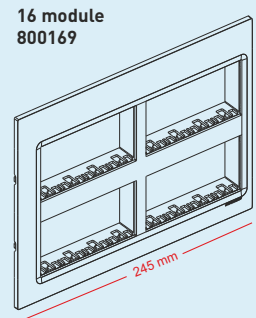

18 module
800170

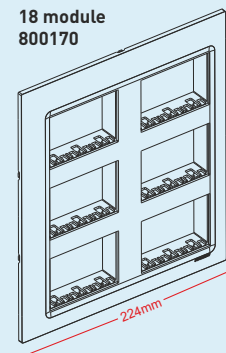

6 module
800176

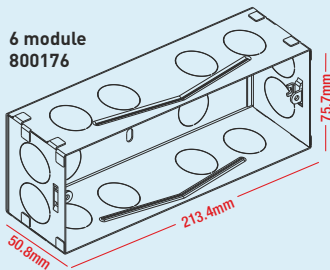

8 module (Horizontal)
800178

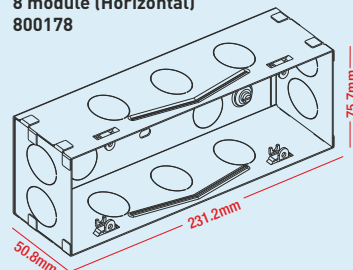

8 module (Vertical)
800177

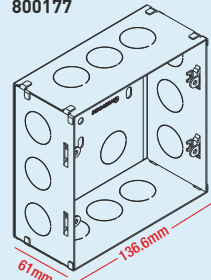

12 module
800175

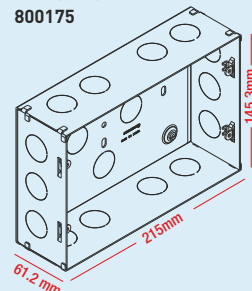

16 module
800179

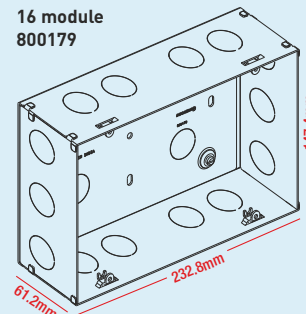

18 module
800180

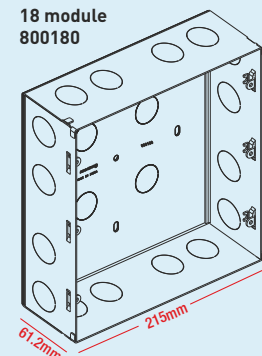

6 module
800186

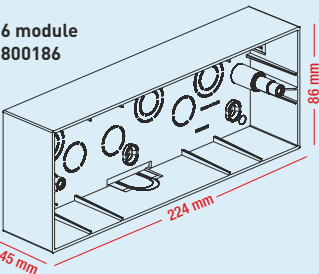

8 module (Horizontal)
800188

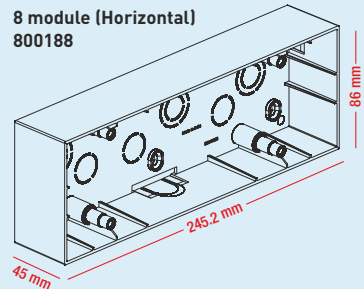

8 module (Vertical)
800187

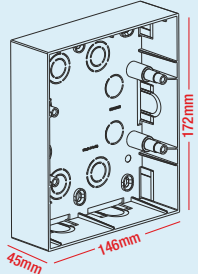

12 module
800185

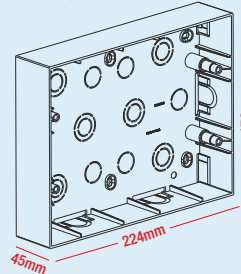

16 module
800189

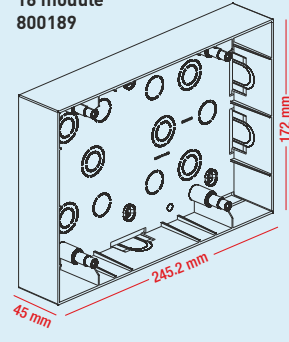

18 module
800190

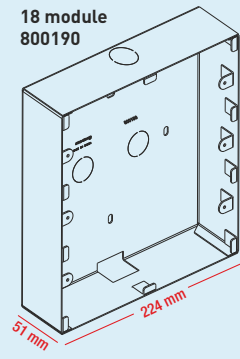

CORPORATE OFFICE:

V. J. Business Towers, A-6, 1st Floor, Sector-125, Noida-201301, U.P., India.
Ph.: +91-0120-3305100
E-mail: sales@indoasian.com, international@indoasian.com
Website: www.indoasian.com

CUSTOMER CARE SUPPORT EXECUTIVE:

V. J. Business Towers, A-6, 1st Floor, Sector-125, Noida-201301, U.P., India.
Ph.: +91-0120-3305111
E-mail: feedback@indoasian.com

NORTH

CHANDIGARH

S.C.O.-11, 2nd Floor,
Sector-26, Madhya Marg,
Chandigarh-160002
Ph.: 0172-3934651
E-Mail: in-chandigarh-office@indoasian.com

NOIDA

V. J. Business Towers
A-6, Ground Floor,
Sector-125, Noida-201301
Ph.: 0120-3365300
E-Mail: in-delhi-office@indoasian.com

JAIPUR

433, 4th Floor, Ganpati Plaza,
M. I. Road,
Jaipur-302001
Ph.: 0141-4113528
E-Mail: in-jaipur-office@indoasian.com

LUCKNOW

301, 3rd Floor, Chintel House,
Station Road,
Lucknow-226001
Ph.: 0522-4013210
E-Mail: in-lucknow-office@indoasian.com

SOUTH

BANGALORE

787, 1st Floor "Skyline Vista"
15th Cross, 100 Feet Ring Road
J P Nagar 1st Phase
Bangalore-560 078
Tel: 080-46219999
E-Mail: in-bangalore-office@indoasian.com

COCHIN

Door No.65/1317, Syda Building,
2nd Floor, Kaloor-Kadavanthra Road,
Kaloor, Ernakulam District,
Kochi-682017 (Kerala)
Ph.: 0484-4055581-88
E-Mail: in-cochin-office@indoasian.com

COIMBATORE

Door No. 83,
Dr. Nanjappa Road,
Coimbatore-641018
Ph.: 0422-2302715
E-Mail: in-coimbatore-office@indoasian.com

CHENNAI

No.5, 1st Floor, Mahalingapuram Main Road,
Nungambakkam,
Chennai-600034
Ph.: 044-28172096, 28170527
E-Mail: in-chennai-office@indoasian.com

HYDERABAD

312, 3rd Floor,
Amrutha Estates, Himayath Nagar,
Hyderabad-500029
Ph.: 040-66742425
E-Mail: in-secunderabad-office@indoasian.com

WEST

AHMEDABAD

102, 1st Floor, Shivalik High Street,
Near Mansi Circle, Vastrapur,
Ahmedabad-380015
Ph.: 079-29701351-53
E-Mail: in-ahmedabad-office@indoasian.com

INDORE

202, KK Bafna Arcade,
Janjeerwala Square, Race Course Road,
Indore-452001
Ph.: 0731-4064064
E-Mail: in-indore-office@indoasian.com

MUMBAI

401 & 408, K.P. Arrum,
Marol Morshi Road, Andheri East,
Mumbai-400059
Ph.: 022-61035800
E-Mail: in-mumbai-office@indoasian.com

PUNE

1307, 4th Floor, Rajadwar Building,
Off. J. M. Road, Shivaji Nagar,
Pune-411005
Ph.: 020-60500440
E-Mail: in-pune-office@indoasian.com

EAST

KOLKATA

"Raikva Building" Room No. 8, 2nd Floor,
3A Ram Mohan Garden Lane,
Beliaghata E.M.Bypass, Kolkata-700010
Ph.: 033-66041503
E-Mail: in-kolkata-office@indoasian.com